

ULINE H-2449
GARMENT STORAGE
CENTER WITH SHELVES

1-800-295-5510
 uline.com

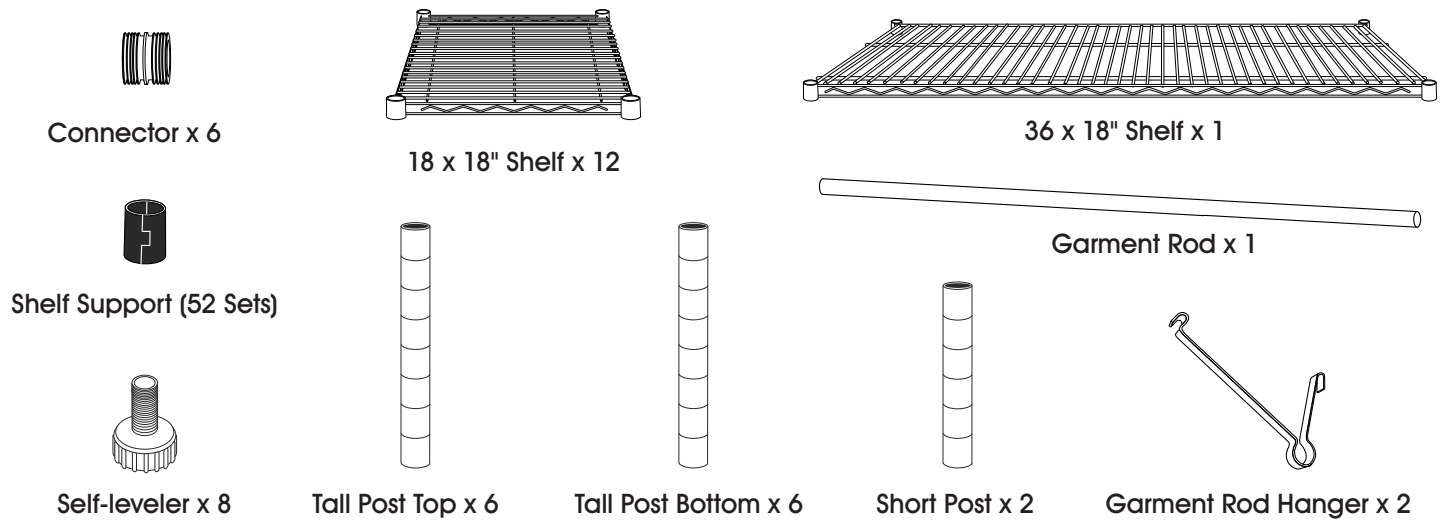

PARTS



ASSEMBLY

POST ASSEMBLY

1. Connect tall post tops and tall post bottoms to each other by screwing them together. (See Figure 1)

 **NOTE:** Tall post tops have a black plastic cap in the top of the post.

Figure 1



TO INSTALL SELF-LEVELERS

1. Make sure post is positioned as shown. (See Figure 2)

Figure 2

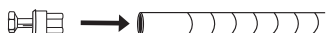

2. Insert self-leveler into open end of post. Tap on ground to slide self-leveler into post.
3. Repeat step 2 for all other posts.

TO INSTALL OPTIONAL CASTERS

1. Make sure post is positioned as shown. (See Figure 3)
2. Engage the wheel brakes to keep casters from rolling during assembly. Use a rubber mallet to tap caster stem into posts. (See Figure 3)

Figure 3

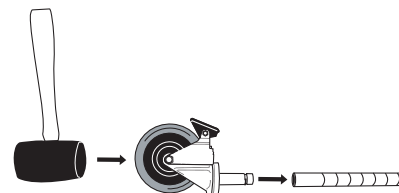

ASSEMBLY CONTINUED

UNIT ASSEMBLY

1. Snap shelf supports into the very bottom groove of two short and two tall posts. (See Figure 4)
2. Slide posts through underside of square shelf until it slides firmly over the supports. (See Figure 5)

Figure 4

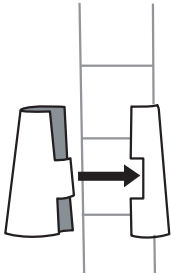
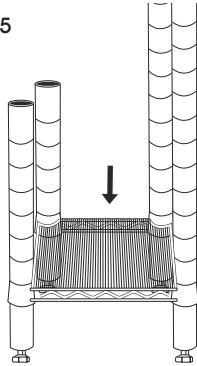
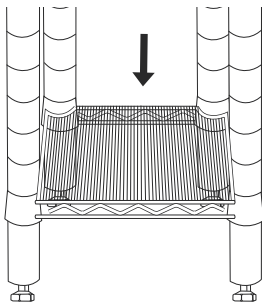

Figure 5



3. Take the other four tall posts, snap shelf supports into the very bottom groove on all four posts. Slide posts through underside of square shelf until it slides firmly over the supports. (See Figure 6)

Figure 6



4. Position each set of four posts as shown and snap four sets of shelf supports into the groove directly above the square shelves of the inner four posts. (See Figure 7)

Figure 7

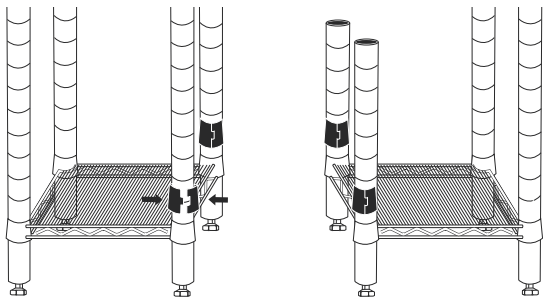

5. Slide a square shelf onto the inner four posts until shelf slides firmly over the supports. (See Figure 8)

Figure 8

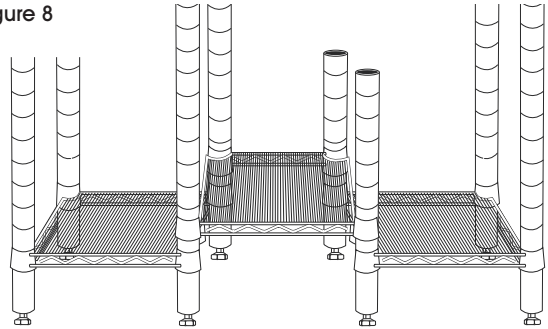

6. Snap four sets of shelf supports onto the outer posts with 5 grooves visible. And 4 sets of shelf supports on the inner posts with 3 grooves visible. (See Figure 9)

Figure 9

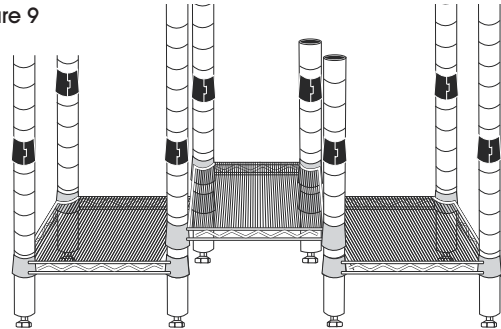

7. Slide two square shelves onto the posts until shelves slide firmly over the supports. (See Figure 10)

Figure 10

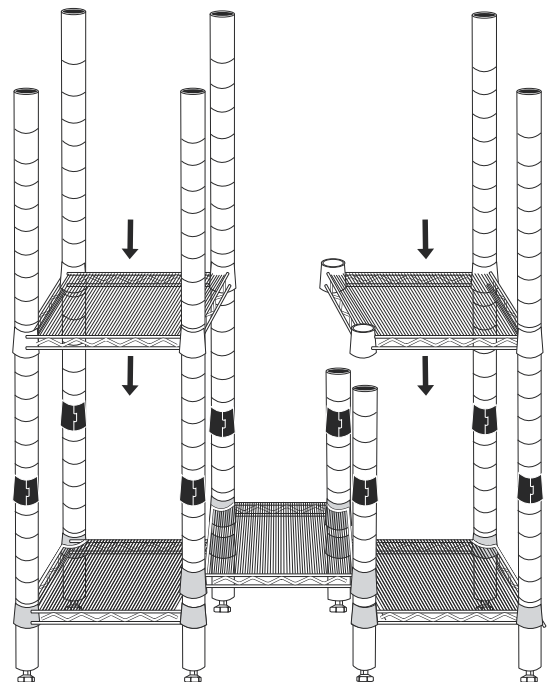

ASSEMBLY CONTINUED

UNIT ASSEMBLY CONTINUED

8. Snap eight sets of shelf supports onto the posts with five grooves visible on all eight posts. Slide two square shelves onto the posts until shelves slide firmly over the supports.
9. Repeat step 8 one more time. (See Figure 11)

Figure 11

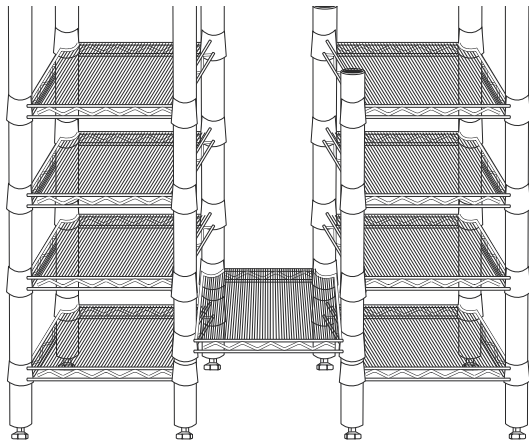

LEFT SIDE OF THE UNIT

10. Snap four sets of shelf supports onto the left four posts with twelve grooves visible between the lower shelf.
11. Slide a square shelf onto the posts until shelf slides firmly over the supports. (See Figure 12)
12. Repeat steps 10 and 11 twice. (See Figure 12)

Figure 12

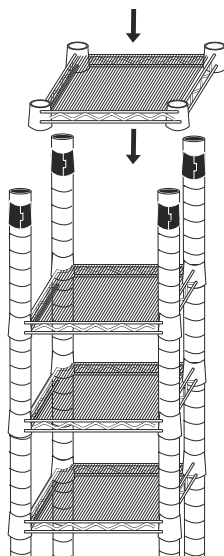

RIGHT SIDE OF THE UNIT

13. Snap four sets of shelf supports onto two inner posts and two outer posts. (See Figure 13)
14. Slide the rectangular shelf at the top of the posts until shelf slides firmly over the supports. (See Figure 13)

Figure 13

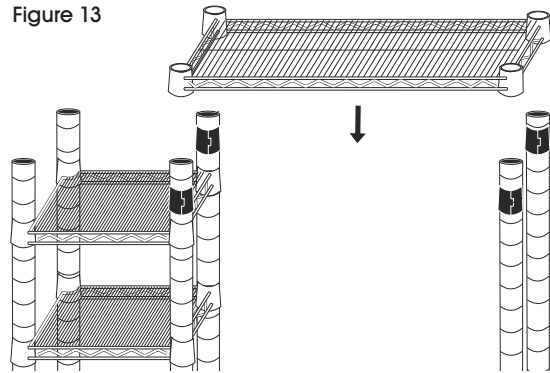

15. Slide garment rod hangers onto garment rod. (See Figure 14)

Figure 14



16. Slide the longer end of garment rod hangers through the shelf wires. (See Figure 15)

Figure 15

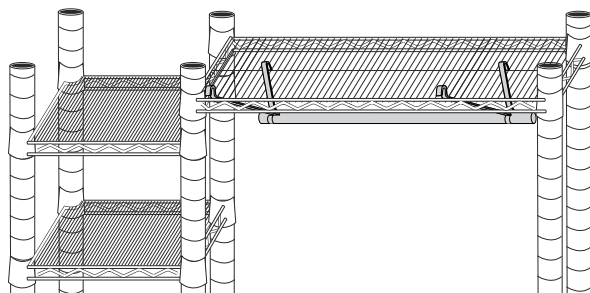

17. Hook the short end of garment rod hangers onto the center wire of the shelf. (See Figure 16)

18. Pull garment rod back and down, one side at a time, until long end of garment rod hanger snaps into place.

Figure 16

