

**ULINE** H-2603, H-2604  
**SHOP-VAC® WET/DRY**  
**VACUUM**

1-800-295-5510  
uline.com

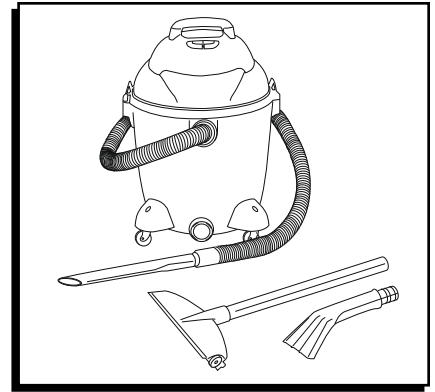

## IMPORTANT SAFETY INSTRUCTIONS



**ATTENTION:** Read all safety rules carefully before attempting to operate. Retain for future reference.



**CAUTION:** Never operate this unit when flammable materials or vapors are present because electrical devices produce arcs or sparks that can cause a fire or explosion. **NEVER OPERATE UNATTENDED.**

### H-2603 AND H-2604 SHOP VACS

The Shop-Vac® Wet/Dry vacuum cleaners are for vacuuming wet and dry nonvolatile materials. Equipped with powerful, permanently lubricated motors and standard filtration systems. Double filtration is available for most Shop-Vac® models and is standard on Shop-Vac® commercial vacuums. Equipped with easy roll caster system. Automatic float shut off prevents overflow during wet pick-up. Includes versatile 1½" (3.81cm) diameter accessories and rugged dent resistant polypropylene tank. UL listed.

### TO REDUCE THE RISK OF FIRE, ELECTRIC SHOCK OR INJURY:

1. Do not leave appliance unattended when plugged in. Unplug from outlet when not in use and before servicing. Connect to a properly grounded outlet only. See Grounding Instructions on page 2.
2. Do not expose to rain—store indoors.
3. Do not allow to be used as a toy. Close attention is necessary when used by or near children.
4. Use only as described in these instructions. Use only manufacturer's recommended attachments.
5. Do not use with damaged cord or plug. If appliance is not working as it should, has been dropped, damaged, left outdoors or dropped into water, contact Uline Customer Service for assistance.
6. Do not: Pull or carry by cord, use cord as a handle, close a door on cord, pull cord around sharp edges or corners or run appliance over cord.
7. Keep cord away from heated surfaces.
8. Do not unplug by pulling on cord. To unplug, grasp the plug, not the cord.
9. Do not handle plug or appliance with wet hands.
10. Do not put any object into openings. Do not use with any openings blocked; keep free of dust, lint, hair and anything that may reduce air flow.
11. Keep hair, loose clothing, fingers and all parts of body away from openings and moving parts.
12. Do not pick up anything that is burning or smoking, such as cigarettes, matches or hot ashes.
13. Do not use without dust bag and/or filters in place.
14. Turn off all controls before unplugging.
15. Use extra care when cleaning on stairs.
16. Do not use to pick up flammable or combustible liquids, such as gasoline, or use in areas where they may be present.
17. Do not use as a sprayer of flammable liquids such as oil-base paints, lacquers, household cleaners, etc.
18. Do not vacuum toxic, carcinogenic, combustible or other hazardous materials such as asbestos, arsenic, barium, beryllium, lead, pesticides or other health-endangering materials. Specially designed units are available for these purposes.
19. Do not pick up soot, cement, plaster or drywall dust without cartridge filter and collection filter bag in place. These are very fine particles that may pass through the foam and affect the performance of the motor or be exhausted back into the air. Additional collection filter bags are available.
20. Do not leave the cord lying on the floor after cleaning. It can become a tripping hazard.
21. Use special care when emptying heavily loaded tanks.
22. To avoid spontaneous combustion, empty tank after each use.

23. The operation of a utility vac can result in foreign objects being blown into eyes, which can result in eye damage. Always wear safety goggles when operating vacuum.



**STAY ALERT!** Watch what you are doing and use common sense. Do not use vacuum cleaner when you are tired, distracted, or under the use of drugs, alcohol or medication causing diminished control.

## GROUNDING INSTRUCTIONS

This appliance must be grounded. If it should malfunction or breakdown, grounding provides a path of least resistance for electric current to reduce the risk of electric shock. This appliance is equipped with a cord having an equipment-grounding conductor and grounding plug. The plug must be inserted into an appropriate outlet that is properly installed and grounded in accordance with all local codes and ordinances.



**WARNING:** Improper connection of the equipment-grounding conductor can result in a risk of electric shock. Check with a qualified electrician or service person if you are in doubt as to whether the outlet is properly grounded. Do not modify the plug provided with the appliance—if it will not fit the outlet, have a proper outlet installed by a qualified electrician.

1. This appliance is for use on a nominal 120-volt circuit, and has a grounded plug that looks like the plug illustrated in sketch A. (See Figure 1)
2. A temporary adapter, like the adapter illustrated in sketches B and C, may be used to connect this plug to a 2-pole receptacle (as shown in sketch B) if a properly grounded outlet is not available. (See Figure 1)

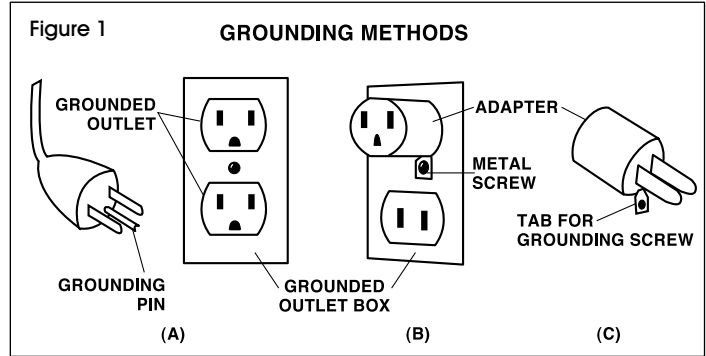

3. The temporary adapter should be used only until a properly grounded outlet (sketch A) can be installed by a qualified electrician. The green colored rigid ear, lug or the like extending from the adapter must be connected to a permanent ground such as a properly grounded outlet box cover. Whenever the adapter is used, it must be held in place by a metal screw. (See Figure 1)



**NOTE:** In Canada, the use of a temporary adaptor is not permitted by the Canadian Electrical Code. Make sure that the appliance is connected to an outlet having the same configuration as the plug. No adapter should be used with this appliance.

## EXTENSION CORDS

When using the appliance at a distance where an extension cord becomes necessary, a 3-conductor grounding cord of adequate size must be used for safety and to prevent loss of power and overheating. Use the table below to determine A.W.G. wire size required. To determine ampere rating of your vacuum, refer to nameplate located on rear of motor cover.

Before using appliance, inspect power cord for loose or exposed wires and damaged insulation. Make any needed repairs or replacements before using your appliance. Use only three-wire outdoor extension cords that have three-prong grounding-type plugs and three-pole receptacles that accept the extension cord's plug. When vacuuming liquids, be sure the extension cord connection does not come in contact with the liquid.



**NOTE:** Static shocks are common in dry areas or when the relative humidity of the air is low. This is only temporary and does not affect the use of the appliance. To reduce the frequency of static shocks in your home, the best remedy is to add moisture to the air with a console or installed humidifier.

VOLTS		TOTAL LENGTH OF CORD IN FEET			
120V		25	50	100	150
AMPERE RATING		AMERICAN WIRE GAUGE (AWG)			
More Than	Not More Than				
0	6	18	16	16	14
6	10	18	16	14	12
10	12	16	16	14	12
12	16	14	12	Not recommended	

# UNPACKING

1. Remove vacuum cleaner and all accessories from the carton.
2. **IMPORTANT:** Open tank cover by pushing latches or clamps outward with thumbs and remove any accessories that may have been shipped in the tank.
3. Assemble caster system following the instructions below.
4. Depending on dry pick-up or wet pick-up operation, install proper filter. (See page 4 for filter guide)
5. Replace cover and make sure latches or clamps are secured over raised area of tank cover.







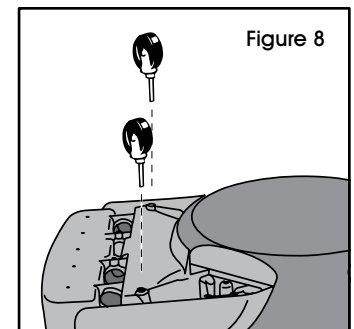
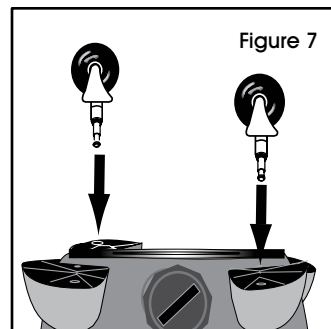
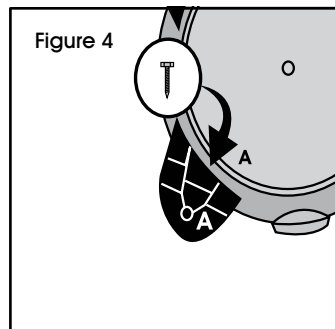
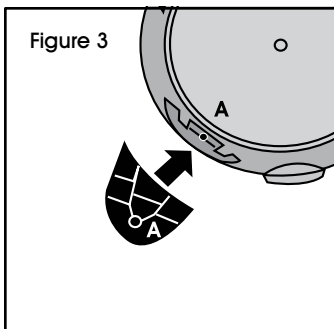
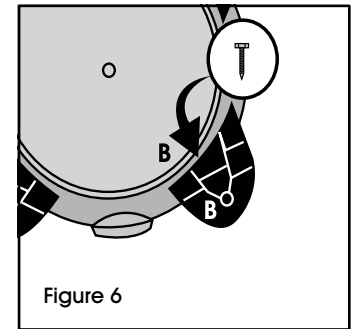
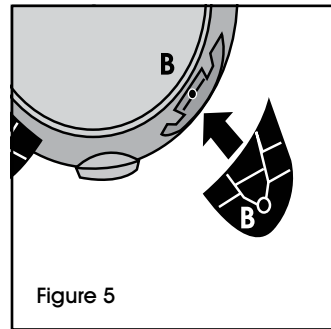
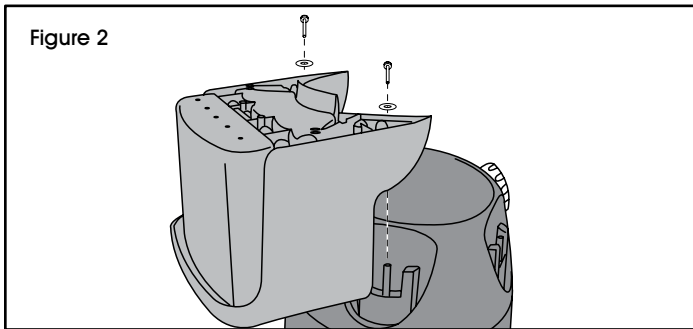

# ASSEMBLY

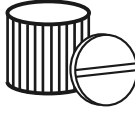
## REAR CASTER ACCESSORY CADDY AND FRONT CASTER FEET ASSEMBLY

1. With cord disconnected from receptacle and tank cover removed, turn tank upside down so the bottom is facing up. (See Figure 2)
2. Take accessory caddy and place into slots (on rear of tank opposite of drain). Secure with screws and washers provided. (See Figure 2)
3. With tank drain facing you, take caster foot marked with the letter A and place in slot on left side of tank also marked with the letter A. (See Figure 3)
4. Secure with screw provided. (See Figure 4)
5. Take caster foot marked with the letter B and place in slot on right side of tank also marked with the letter B. (See Figure 5)
6. Secure with screw provided. (See Figure 6)
7. Install casters into caster feet by inserting the caster stems into the holes provided. Apply pressure and twisting motion until casters snap into place. (See Figure 7)
8. Install casters into accessory caddy by inserting the caster stems into the holes provided. Apply pressure and twisting motion until casters snap into place. (See Figure 8)

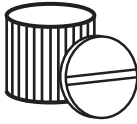

# FILTERS

BEST	BETTER	GOOD
		
<p><b>High Efficiency Collection Filter Bags</b></p> <ul style="list-style-type: none"> <li>• Dry pick-up only</li> <li>• Fine dust and particles</li> <li>• Easy to install and use</li> <li>• Reduces loss of suction</li> </ul>	<p><b>Ultra Web® Cartridge Filter**</b></p> <ul style="list-style-type: none"> <li>• Wet or dry pick-up</li> <li>• Easy cleanup</li> <li>• Fine dust and particles</li> </ul>	<p><b>Reusable Disc Filter</b></p> <ul style="list-style-type: none"> <li>• Dry pick-up only</li> <li>• General purpose</li> <li>• Reusable disc</li> </ul>
		
<p><b>HEPA CleanStream® Cartridge Filter*</b></p> <ul style="list-style-type: none"> <li>• Wet or dry pick-up</li> <li>• Non-stick surface</li> <li>• Easy cleanup</li> <li>• Efficient, easy to use</li> <li>• Fine dust and particles</li> </ul>	<p><b>Super Performance Polyester Filter</b></p> <ul style="list-style-type: none"> <li>• Dry pick-up only</li> <li>• General purpose</li> <li>• Reusable cloth filter</li> </ul>	<p><b>Cloth Filter</b></p> <ul style="list-style-type: none"> <li>• Dry pick-up only</li> <li>• General purpose</li> <li>• Reusable cloth filter</li> </ul>
		
<p><b>HEPA Abrasion Resistant Cartridge Filter</b></p> <ul style="list-style-type: none"> <li>• Wet or dry pick-up</li> <li>• Non-stick surface</li> <li>• Easy cleanup</li> <li>• Efficient, easy to use</li> <li>• Fine dust and particles</li> </ul>	<p><b>Full Polyester Filter</b></p> <ul style="list-style-type: none"> <li>• Dry pick-up only</li> <li>• Full circumference tank filter</li> <li>• Durable, reusable, economical</li> </ul>	<p><b>Foam Sleeve</b></p> <ul style="list-style-type: none"> <li>• Wet pick-up only</li> <li>• Use as a secondary filter with all other Shop-Vac® filters except Cartridge and HEPA Cartridge filters</li> <li>• Reusable foam</li> </ul>
		
<p><b>HEPA Cartridge Filter</b></p> <ul style="list-style-type: none"> <li>• Dry pick-up only</li> <li>• Efficient, easy to use</li> <li>• Fine dust and particles</li> </ul>		

\*CleanStream, Gore and designs are trademarks of W.L. Gore & Associates, Inc.

\*\*Ultra Web is a registered trademark of Donaldson Co., Inc.

## FILTER COMBINATIONS

CAGE FILTERS		TANK FILTERS
Cartridge Filters	<b>PLUS</b>	High Efficiency Collection Filter Bags
Foam Sleeve		Full Polyester Filter
Reusable Disc		
Cloth Filter		
Super Performance Polyester Filter		

# OPERATION

## WET PICK-UP

See the Shop-Vac® vacuum filter guide on page 4 to determine which type of wet filtration is best for your needs. Remove the dry filters plus all dirt and debris found in the tank assembly. Wet pick-up requires only the foam sleeve **OR** cartridge filter to be in place. Do not use dry filters for wet pick-up. When picking up several tanks full of liquid, the filter will become saturated and misting may appear in the exhaust air. At this time, you should dry the filter or change to a dry filter to eliminate the misting and possible dripping of liquid around the lid. After completing a wet pick-up job, raise the hose to drain into tank before shutting off the vac. The interior of the tank should be periodically rinsed clean.

 **NOTE:** Wet pick-up accessories should be washed periodically with soap and water, especially after picking up wet, sticky liquids.

## DRY PICK-UP

See the Shop-Vac® vacuum filter guide on page 4 to determine which type of dry filtration is best for your needs. Better quality filtration is required for finer dry materials. Collection filter bags are recommended for very fine materials such as dry wall dust.

 **NOTE:** When using the vacuum to pick up very fine dust, such as sawdust or dry wall dust, it will be necessary to empty the tank and clean the filter at more frequent intervals to maintain maximum pick-up power or upgrade to collection filter bags.

## KEEP FILTERS CLEAN

The efficiency of these vacuum cleaners is largely dependent on the filter. A clogged filter can cause overheating and possibly damage the vacuum cleaner. Clean or replace filters regularly. Do not use the vacuum or filters for collecting hazardous or other health endangering materials.

 **NOTE:** Never machine wash or dry filters.

## CARTRIDGE FILTER MAINTENANCE

This filter is made of high-quality paper designed to stop small particles of dust. The filter can be used for wet or dry pick-up. A dry filter is necessary to pick up dry material. If you use your vac to pick up dust when the filter is wet, the filter will clog quickly and be very difficult to clean. The filter may become saturated when picking up large quantities of liquid, causing misting to appear in the exhaust air. At this time, you should dry or change the filter to eliminate this occurrence. Please handle the filter carefully when removing it for cleaning or when

installing it. Check the filter for tears or small holes. Even a small hole can cause dust to be exhausted. Do not use a filter with holes or tears. Replace it immediately.

## INSTALLING AND CLEANING THE CARTRIDGE

1. Slide cartridge filter down over filter cage. (See Figure 9)
2. Place filter retainer on top of cartridge filter. (See Figure 10)
3. Hold onto base of lid cage with one hand and turn retainer clockwise to tighten. (See Figure 11)
4. To remove filter for cleaning, hold onto base of lid cage with one hand and turn retainer counterclockwise to loosen. (See Figure 12)
5. Slide cartridge filter off filter cage. (See Figure 13)
6. Clean wet filter by rinsing from the inside. (See Figure 14)
7. Clean dry filter by tapping it on inside of waste can. (See Figure 15)
8. When wet (to prevent mold and/or mildew build-up), the cartridge filter should be removed and allowed to air dry for a 24-hour period before being re-installed back onto the filter cage.

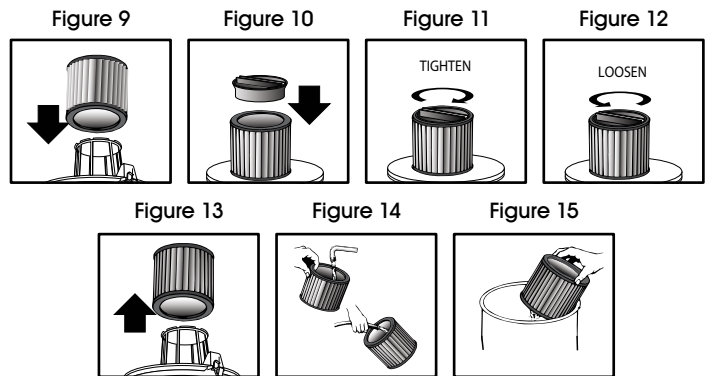

## BLOWER USE

The H-2603 and H-2604 Shop-Vacs® can be used as powerful blowers by inserting the hose into the motor housing exhaust port. To use as a blower:

1. Clear hose of any obstructions.
2. Insert hose end into blower port on rear of unit. Twist slightly to tighten.
3. Caution should be used when using attachment due to the powerful force of air.

# OPERATION CONTINUED

## AUTOMATIC SHUTOFF

The vacuum cleaner is equipped with an automatic shutoff that operates when picking up liquids. When the liquid in the tank reaches a certain level, an internal float will seat itself against a seal at the intake of the motor, shutting off suction. When this happens, the motor will develop a higher than normal pitch noise indicating that you need to shut off the vacuum and empty the liquid.

 **NOTE:** If accidentally tipped over, the float shutoff device could seat against the seal and shut off suction. If this happens, simply place the vacuum cleaner in upright position and turn off the switch until the float returns to its normal position.

## EMPTYING THE TANK

 **CAUTION:** Use special care when emptying heavily loaded tanks.

The wet/dry vacuum may be emptied of liquid waste by removing the tank cover. To empty, switch off the vacuum and remove the plug from the wall receptacle. Remove the tank cover and empty the tank.

 **NOTE:** Tank can also be emptied by removing drain cap and draining liquid waste into a suitable drain.

## STORAGE

Before storing the vacuum cleaner, always empty and clean the tank. Never allow liquids to sit in the tank for any extended period of time.

 **NOTE:** Always store the vacuum cleaner indoors.

## LUBRICATION

No lubrication is necessary as the motor is equipped with lifetime lubricated bearings.

## MAINTENANCE

 **WARNING:** Be sure to disconnect power supply before attempting to service or remove any components.

## SERVICE

Do not attempt to service your Shop-Vac® wet/dry vacuum cleaner beyond that described in these instructions. Refer all other servicing to Uline Customer Service.

 **WARNING:** If any of the motor housing parts should become detached or broken, exposing the motor or any other electrical components, operation should be discontinued immediately to avoid personal injury or further damage to the vacuum. Repairs should be made before reusing the vacuum.

# ACCESSORIES, HOSES AND WANDS

## NOZZLES AND ACCESSORIES

All friction fit accessories - Insert wand end or hose into accessory and twist to form a tight fit. (See Figure 16)

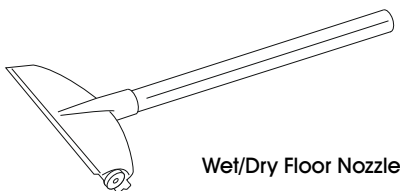

Wet/Dry Floor Nozzle

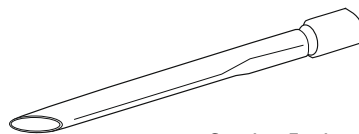

Crevice Tool

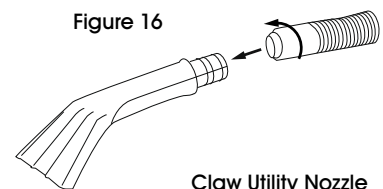

Claw Utility Nozzle

## HOSES

Lock-On® Hoses - Insert hose collar onto threaded tank inlet and tighten. (See Figure 17)

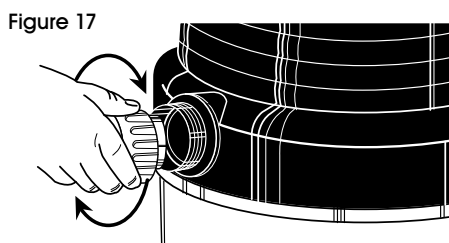

Figure 17

## WANDS

Friction fit wands - Insert wand ends together and twist to form a tight fit. (See Figure 18)

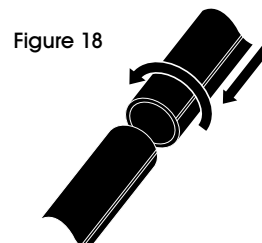

Figure 18

# SHOP-VAC® VACUUM FILTER CLEANING REFERENCE



Foam Sleeve



Full Polyester Sleeve



Super Performance Filter



Reusable Disk Filter



CleanStream® Abrasion Resistant Cartridge Filter



Cartridge Filter & Ultra Web® Cartridge Filter

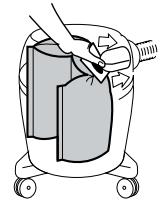

All Collection Bags

FILTER	CLEANING INSTRUCTIONS
Foam Sleeve	Rinse with water, dry and reinstall.
Full Polyester Filter	Brush off dirt and reinstall; if filter gets wet, rinse with water, dry and reinstall.
Super Performance Filter	Dispose of after filter develops rips or tears.
Reusable Disk Filter	Rinse with water, dry and reinstall. <b>Important:</b> do not machine wash.
CleanStream® Abrasion Resistant Cartridge Filter	Clean installed filter by tapping or shaking the vacuum unit. To restore optimum airflow, remove filter and tap end cap against a hard surface to loosen debris. Additional debris can be removed by rinsing outside surface of filter with running water. Avoid dampening inside of filter. Completely air dry filter after washing. <b>Important:</b> DO NOT brush. DO NOT clean filter media with abrasive materials. DO NOT scrub to clean between pleats. This will permanently damage the filter's ability to stop dust.
Cartridge Filter & Ultra Web® Cartridge Filter	From inside of filter, rinse with water, dry completely and reinstall.
All Collection Bags	Dispose of bag when full.

## TROUBLESHOOTING

ISSUE	POSSIBLE CAUSE(S)	CORRECTIVE ACTION
Parts/accessories missing	Packed in tank	Check in tank
Vacuum cleaner will not start	<ol style="list-style-type: none"> <li>No power at receptacle</li> <li>Defective switch</li> <li>Defective motor</li> </ol>	<ol style="list-style-type: none"> <li>Check for power</li> <li>Replace switch</li> <li>Replace motor</li> </ol>
Dust discharging from exhaust	<ol style="list-style-type: none"> <li>Filter not installed or installed improperly</li> <li>Filter damaged</li> <li>Filter clogged or dust is too fine</li> <li>Filter not functional</li> </ol>	<ol style="list-style-type: none"> <li>Properly install filter</li> <li>Replace filter</li> <li>Use more efficient filter</li> <li>Clean and replace filter</li> </ol>
Loss of suction	<ol style="list-style-type: none"> <li>Loose hose connection</li> <li>Filter clogged</li> <li>Full tank</li> <li>Hole in hose</li> </ol>	<ol style="list-style-type: none"> <li>Tighten hose connection</li> <li>Clean or replace filter</li> <li>Empty tank</li> <li>Replace hose</li> </ol>
Static shock	<ol style="list-style-type: none"> <li>Dry environment</li> <li>Relative humidity of air is low</li> </ol>	<ol style="list-style-type: none"> <li>Add moisture to air (if practical, use a console or installed humidifier)</li> <li>This situation is temporary and does not affect the use of the vacuum cleaner</li> </ol>

**ULINE** CHICAGO • ATLANTA • DALLAS • LOS ANGELES • MINNEAPOLIS • NYC/PHILA • SEATTLE • MEXICO • CANADA

1-800-295-5510

uline.com