

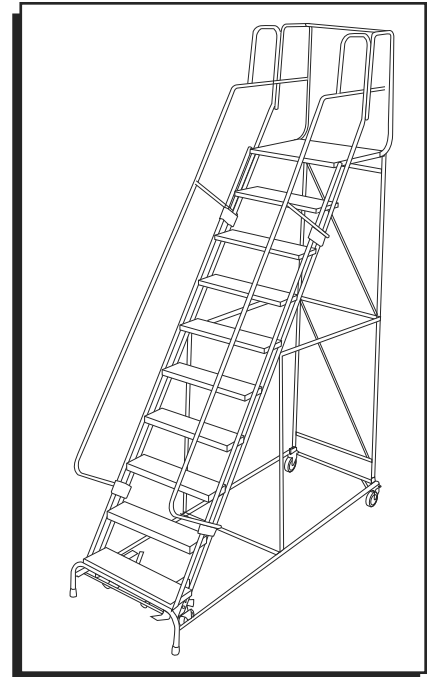

1-800-295-5510
 uline.com

8-12 STEP ROLLING SAFETY LADDERS

20" AND 30" DEEP TOP STEP



TOOLS NEEDED



Step Ladder

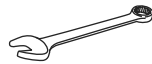

9/16" Wrench or Socket (2)



7/16" Wrench or Socket



Rubber Mallet



Safety Glasses

PARTS

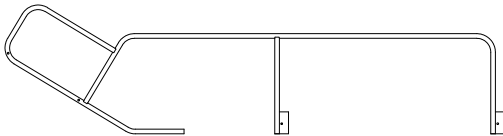

A. Side Handrail (1)
 B. Side Handrail (1) Opposite



C. Rear Handrail Bar (2)
 (shipped taped to handrail or extension panel)

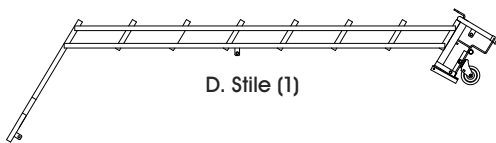

D. Stile (1)

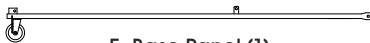

E. Base Panel (1)

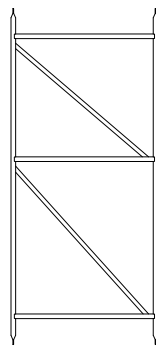

F. Back Panel (1)



G. Horizontal Brace (2)



H. Vertical Brace (2)

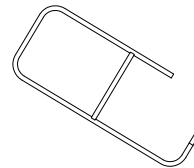

J. Handrail Extension Panel (2)

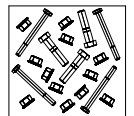

Hardware Kit (1)
 (misc. hardware included)



Handrail Bracket (6)
 (shipped attached to handrail)



Notched Bushing (2 or 4)



Extension Clamps Set (4)



Gray Bushing (6)

ASSEMBLY



WARNING! Assembly of these types of ladders can be inherently dangerous. Please take all necessary precautions during the assembly process. Always use a separate ladder to finish assembly in high places. Never climb a ladder that is not completely assembled. Do not assemble or use a ladder with missing or damaged parts. Use proper lifting mechanics when assembling a ladder. Watch for overhead electrical hazards and obstructions.

STEP 1: FRAME ASSEMBLY



NOTE: DO NOT tighten bolts until instructed to.



NOTE: Back panel (F) has both round and slotted holes. The round holes are at the bottom, and the slotted holes are at the top (L1).

1. Place the ladder stile (D) on the floor. Be sure to assemble on a protective surface so the finish does not get damaged. (See Figure 1)

ASSEMBLY CONTINUED

STEP 1: FRAME ASSEMBLY CONTINUED

- Using (6) 3/8-16 x 1/4" hex head cap screws and self-locking nuts, bolt the top (slotted hole) of back panel (F) to the insides of L1. (See Figure 1)
- Bolt the bottom (round hole) of back panel (F) & back of base panel (E) to the insides of L2. Bolt the front of base panel (E) to the insides of L3. (See Figure 1)

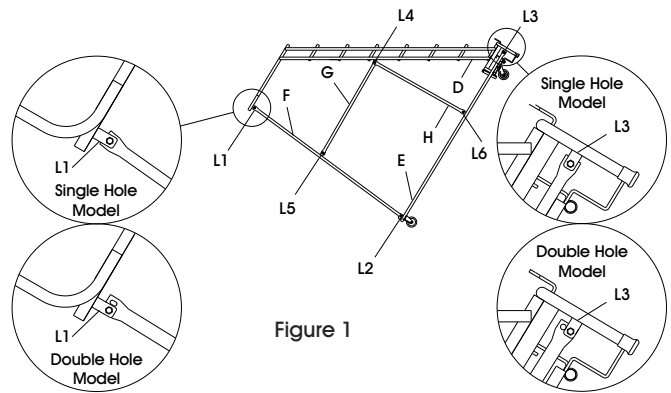

STEP 2: HORIZONTAL AND VERTICAL BRACE ASSEMBLY

NOTE: DO NOT tighten bolts until instructed to.

- Using (3) 3/8-16 x 1/4" hex head cap screws, locate horizontal brace (G) on the outside of L4 and L5.
- Locate the vertical brace (H) on the outside of L4 and L6.
- Start (2) self-locking nuts onto screws at L5 and L6.
- Repeat step 2 for other side.

WARNING! Never climb a ladder that is not completely assembled.

STEP 3: INSTALL HANDRAILS

NOTE: DO NOT tighten bolts until instructed to.

- With ladder on its side, install handrail (A) into the rear stile tubes. Use the rubber mallet as needed for mating parts. (See Figure 1)
- Clamp side handrails to outside of stile tubes using detached handrail brackets and 3/8-16 x 2" hex head cap screws, gray bushings and self-locking nuts. (See Figure 2, Step 2)
- Repeat step 3 with side handrail (B).

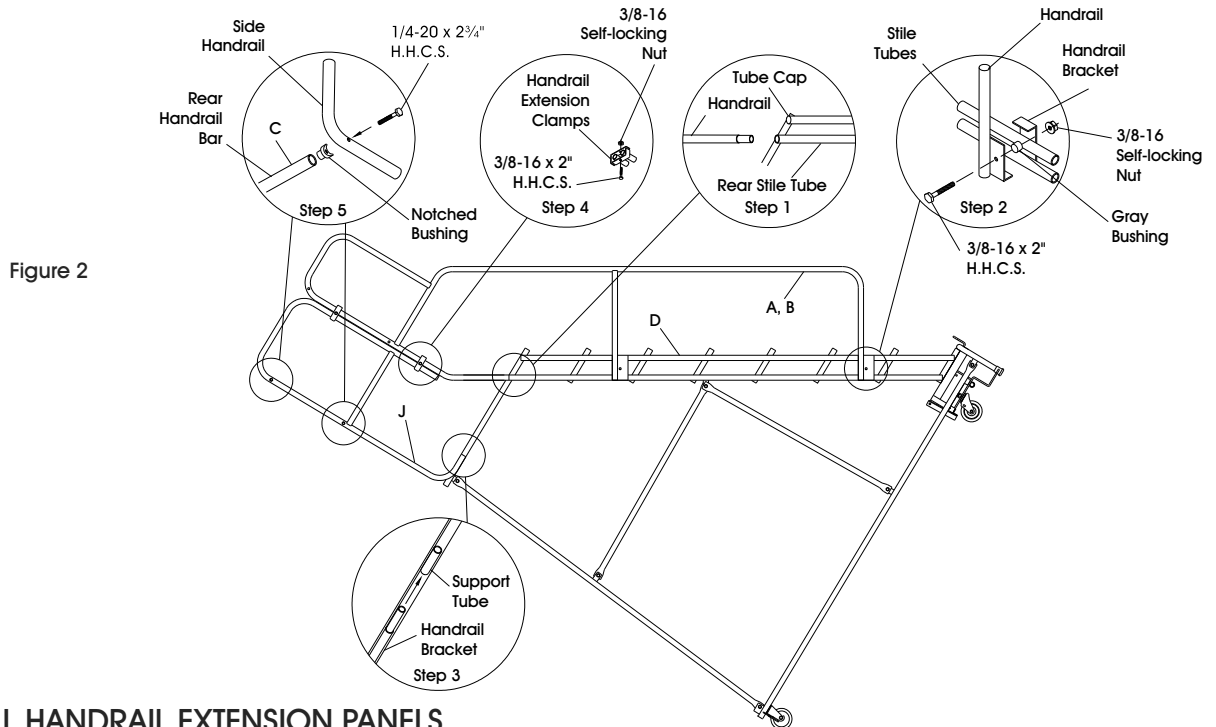

4. STEP 4: INSTALL HANDRAIL EXTENSION PANELS

- Install the handrail extension panels (J) into support tubes located on the sides of the platform. (See Figure 2, Step 3)
- Clamp handrail extension panel to handrail panels using extension clamps and 3/8-16 x 2" hex head cap screws & self-locking nuts. (See Figure 2, Step 4)

ASSEMBLY CONTINUED

STEP 5: INSTALL REAR HANDRAIL BARS

1. Detach rear handrail bar (C) from handrail or extension panel.
2. Insert notched bushing into each end of rear handrail bars (C). (See Figure 2, Step 5)
3. Position rear handrail bars between mounting holes on the top part of side handrails using (4) 1/4-20 x 2³/₄" hex head cap screws.

 **NOTE:** You may now tighten all handrail bolts.

STEP 6: LEVEL LADDER

1. Stand ladder upright on level surface.
2. Activate safelock by stepping on the trip bar located in front of the first step.
3. This sets the ladder on the feet to level.
4. When steps are level, tighten all installed bolts.

 **NOTE:** DO NOT proceed until ladder is stable.

ULINE

1-800-295-5510
uline.com

ULINE

800-295-5510

uline.mx

ESCALERAS DE SEGURIDAD CON RUEDAS DE 8-12 ESCALONES

ESCALÓN SUPERIOR DE 50.8 CM Y 76.2 CM
(20" Y 30") DE PROFUNDIDAD

HERRAMIENTAS NECESARIAS



Escalera



2 Llaves o Dados 9/16"



Llave o Dado 7/16"



Mazo de Hule



Lentes de Seguridad

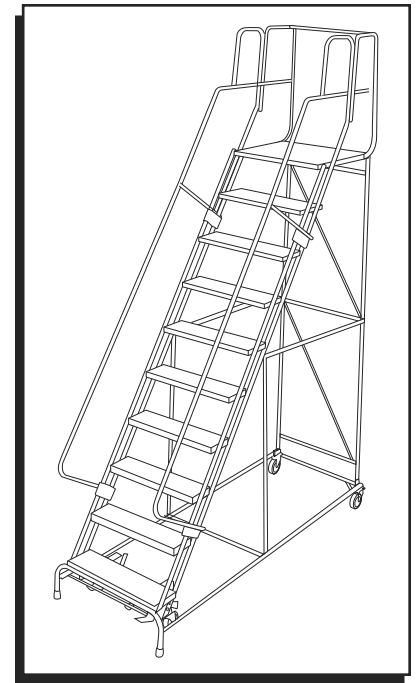

PARTES

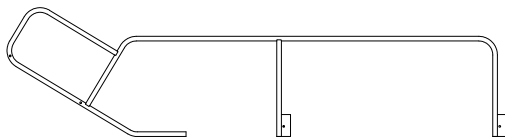

A. 1 Pasamanos Lateral
B. 1 Pasamanos Lateral Opuesto

C. 2 Barras Posteriores de Pasamanos
(se envían anexas al pasamanos
o al panel de extensión)

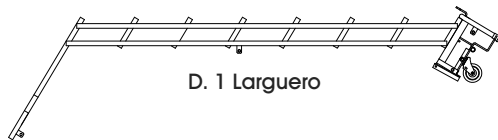

D. 1 Larguero

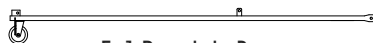

E. 1 Panel de Base

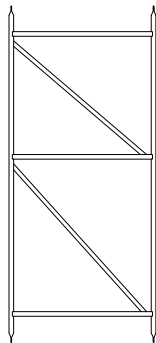

F. 1 Panel Trasero

G. 2 Soportes Horizontales

H. 2 Soportes Verticales

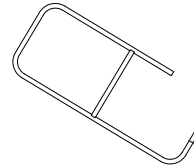

J. 2 Paneles de Extensión del Pasamanos



6 Soportes de Pasamanos
(se envían anexas al pasamanos)



4 Sets de Soportes
de Extensión

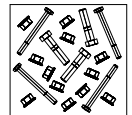

1 Kit de
Accesorios
(incluye diversos
accesorios)



2 o 4 Bujes
Ranurados



6 Bujes Grises

ENSAMBLE



¡ADVERTENCIA! Ensamblar este tipo de escaleras puede ser inherentemente peligroso. Por favor, tome todas las precauciones necesarias durante el proceso de ensamblaje. Siempre utilice otra escalera independiente para terminar el ensamblaje en lugares altos. Nunca suba por una escalera que no está completamente ensamblada. No ensamble o utilice una escalera con partes faltantes o dañadas. Utilice los aparatos adecuados para elevación cuando ensamble una escalera. Observe que no haya peligros eléctricos por encima de su cabeza.

PASO 1: ENSAMBLE EL MARCO



NOTA: NO apriete los pernos hasta que se le indique.



NOTA: El panel trasero (F) tiene orificios redondos y ranurados. Los orificios redondos están en la parte inferior y los ranurados en la parte superior (L1).

1. Coloque el larguero de la escalera (D) sobre el piso. Asegúrese de ensamblar sobre una superficie protegida, para que el acabado no se dañe. (Vea Diagrama 1)

CONTINUACIÓN DE ENSAMBLE

PASO 1: CONTINUACIÓN DE ENSAMBLE DEL MARCO

- Utilizando (6) tornillos de cabeza hexagonal de 3/8-16 x 1 1/4" y contratuercas, atornille la parte superior (orificio ranurado) del panel trasero (F) en el interior de L1. (Vea Diagrama 1)
- Atornille la parte inferior (orificio redondo) del panel trasero (F) y la parte posterior del panel de base (E) en el interior de L2. Atornille el frente del panel de base (E) en el interior de L3. (Vea Diagrama 1)

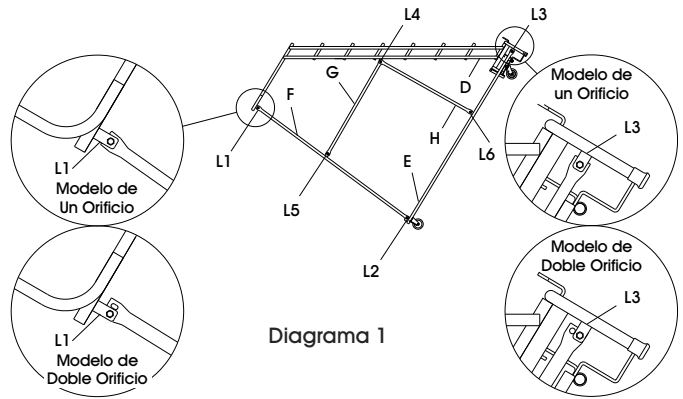

PASO 2: ENSAMBLE EL SOPORTE HORIZONTAL Y VERTICAL

NOTA: NO apriete los pernos hasta que se le indique.

- Utilizando (3) tornillos de cabeza hexagonal de 3/8-16 x 1 1/4", coloque el soporte horizontal (G) en los exteriores de L4 y L5.
- Coloque el soporte vertical (H) en los exteriores de L4 y L6.
- Empiece atornillando las contratuercas (2) en los tornillos de L5 y L6.
- Repita el paso 2 con el otro lado.

¡ADVERTENCIA! Nunca suba por una escalera que no ha sido completamente ensamblada.

PASO 3: INSTALE LOS PASAMANOS

NOTA: NO apriete los pernos hasta que se le indique.

- Con la escalera sobre su lado, instale el pasamanos (A) en los tubos posteriores del larguero. Utilice el mazo de hule como requiera para acoplar las partes. (Vea Diagrama 1)
- Sujete los pasamanos laterales al exterior de los tubos del larguero utilizando los soportes desprendidos del pasamanos, los tornillos de cabeza hexagonal de 3/8-16 x 2", los bujes grises y las contratuercas. (Vea Diagrama 2, Paso 2)
- Repita paso 3 con pasamanos lateral (B).

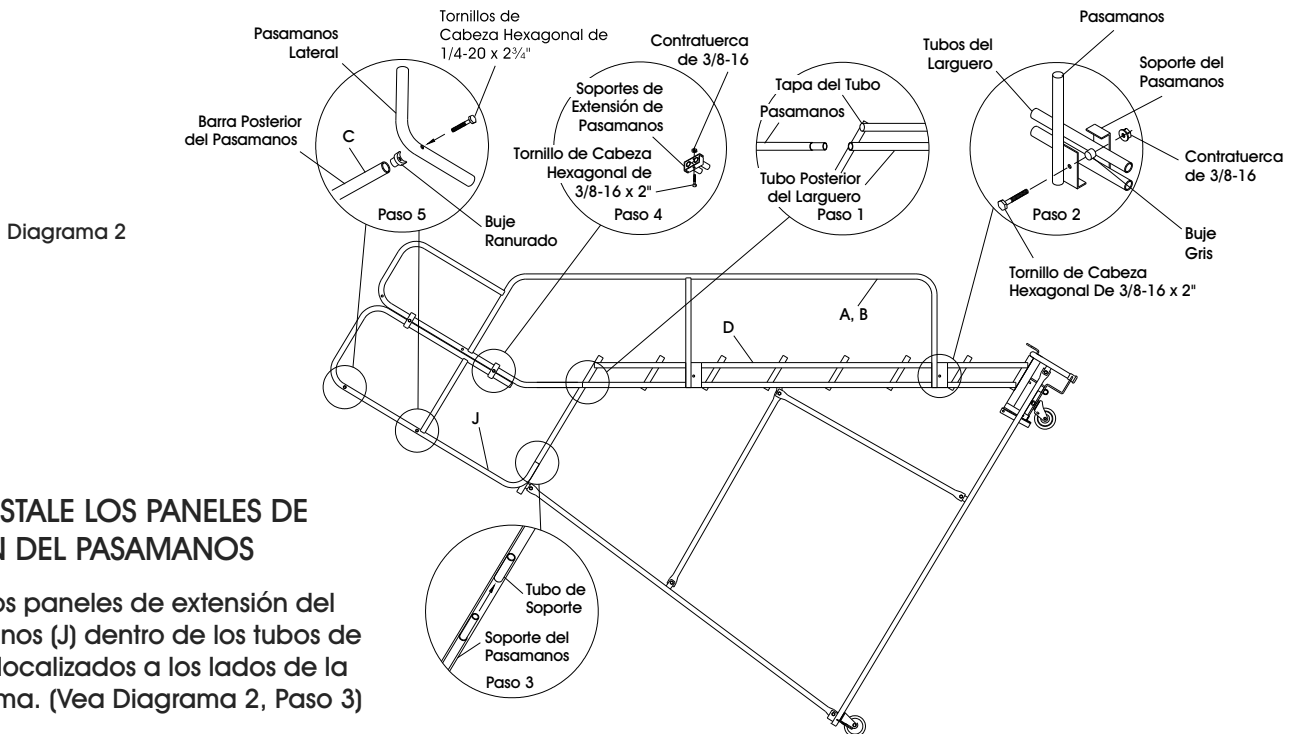

PASO 4: INSTALE LOS PANELES DE EXTENSIÓN DEL PASAMANOS

- Instale los paneles de extensión del pasamanos (J) dentro de los tubos de soporte localizados a los lados de la plataforma. (Vea Diagrama 2, Paso 3)
- Sujete el panel de la extensión del pasamanos a los paneles del pasamanos utilizando los soportes de extensión, tornillos de cabeza hexagonal de 3/8-16 x 2" y contratuercas. (Vea Diagrama 2, Paso 4)

CONTINUACIÓN DE ENSAMBLE

STEP 5: INSTALE LAS BARRAS POSTERIORES DEL PASAMANOS

1. Desprenda la barra posterior del pasamanos (C) del pasamanos o del panel de extensión.
2. Inserte los bujes ranurados en cada extremo de las barras del pasamanos (C). (Vea Diagrama 2, Paso 5)
3. Posicione las barras posteriores del pasamanos entre los orificios de instalación en la parte superior de los pasamanos laterales utilizando (4) tornillos de cabeza hexagonal de 1/4-20 x 2³/₄".



NOTA: Ahora ya puede apretar todos los pernos del pasamanos.

PASO 6: NIVELE LA ESCALERA

1. Pare vertical la escalera sobre una superficie plana.
2. Active el seguro parándose sobre la barra de activación localizada enfrente del primer escalón.
3. Esto coloca la escalera de pie a nivel.
4. Cuando los escalones estén nivelados, apriete todos los pernos.



NOTA: NO proceda hasta que la escalera quede estable.

ULINE

800-295-5510
uline.mx

ULINE

1-800-295-5510
uline.com

ÉCHELLES DE SÉCURITÉ ROULANTES À 8-12 MARCHES

MARCHE SUPÉRIEURE DE 50,8 CM
ET 76,2 CM (20 PO ET 30 PO) DE PROF.

OUTILS REQUIS



Escabeau



Clé ou douille de 9/16 po (2)



Clé ou douille de 7/16 po



Maillet en caoutchouc



Lunettes de sécurité

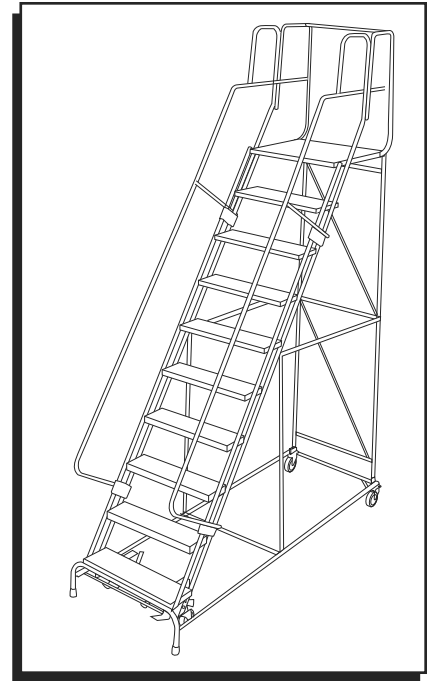

PIÈCES

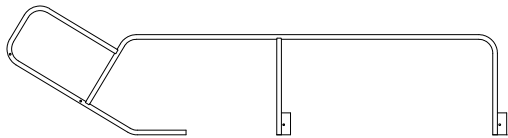

A. Main courante latérale (1)

B. Main courante latérale (1), opposée



C. Barre de main courante arrière (2)
(livrée fixée à la main courante ou au panneau d'extension)

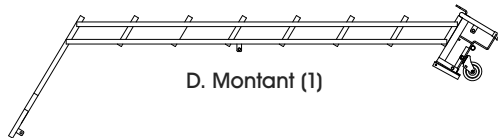

D. Montant (1)

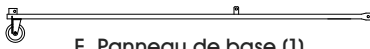

E. Panneau de base (1)

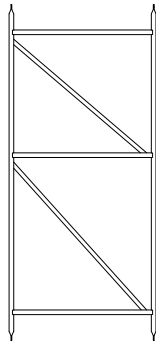

F. Panneau arrière (1)



G. Entretoise horizontale (2)



H. Entretoise verticale (2)

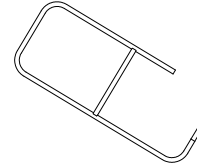

J. Panneau d'extension de main courante (2)



Support de main courante (6)
(livrés fixés à la main courante)

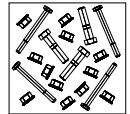

Ensemble de quincaillerie (1)
(pièces diverses incluses)



Bague crantée (2 ou 4)



Jeu d'attaches d'extension (4)



Bague Grise (6)

MONTAGE



AVERTISSEMENT! Le montage de ces types d'échelles peut être dangereux en soi. Veuillez prendre toutes les précautions nécessaires lors du montage. Utilisez toujours une autre échelle pour terminer le montage en hauteur. Ne montez jamais sur une échelle qui n'est pas complètement assemblée. N'assemblez pas et n'utilisez pas une échelle avec des pièces manquantes ou endommagées. Utilisez un dispositif de levage approprié lors du montage d'une échelle. Prenez garde aux dangers électriques et aux obstructions en hauteur.

ÉTAPE 1 : MONTAGE DU CADRE



REMARQUE : NE serrez PAS les boulons à moins d'y être invité.



REMARQUE : Le panneau arrière (F) comporte des trous ronds et des trous fendus. Les trous ronds sont en bas et les trous fendus sont en haut (L1).

1. Placez le montant d'échelle (D) sur le sol. Effectuez le montage sur une surface protectrice afin de ne pas endommager la finition. (Voir Figure 1)

MONTAGE SUITE

ÉTAPE 1 : MONTAGE DU CADRE (SUITE)

- À l'aide de (6) vis d'assemblage à tête hexagonale de 3/8-16 x 1 1/4 po et d'écrous autobloquants, boulonnez le haut (trou fendu) du panneau arrière (F) à l'intérieur de L1. (Voir Figure 1)
- Boulonnez le bas (trou rond) du panneau arrière (F) et l'arrière du panneau de base (E) à l'intérieur de L2. Boulonnez l'avant du panneau de base (E) à l'intérieur de L3. (Voir Figure 1)

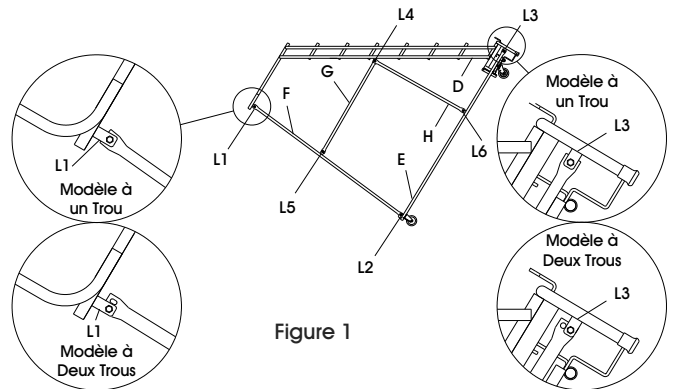

ÉTAPE 2 : MONTAGE DES ENTRETOISES HORIZONTALE ET VERTICALE

REMARQUE : NE serrez PAS les boulons à moins d'y être invité

- À l'aide de (3) vis d'assemblage à tête hexagonale de 3/8-16 x 1 1/4 po, placez l'entretoise horizontale (G) à l'extérieur de L4 et de L5.
- Placez l'entretoise verticale (H) à l'extérieur de L4 et de L6.
- Placez (2) écrous autobloquants sur les vis à L5 et à L6.
- Répétez l'étape 2 pour l'autre côté.



AVERTISSEMENT! Ne montez jamais sur une échelle qui n'est pas complètement assemblée.

ÉTAPE 3 : INSTALLATION DES MAINS COURANTES

REMARQUE : NE serrez PAS les boulons à moins d'y être invité

- Avec l'échelle placée sur son côté, installez la main courante (A) dans les tubes arrière du montant. Au besoin, utilisez le maillet en caoutchouc pour joindre les pièces. (Voir Figure 1)
- Serrez la main courante latérale à l'extérieur des tubes du montant à l'aide des supports détachés de main courante, de vis d'assemblage à tête hexagonale (H.H.C.S.) de 3/8-16 x 2 po, des bagues grises et des écrous autobloquants. (Voir Figure 2, Étape 2)
- Répétez l'étape 3 avec la main courante latérale (B).

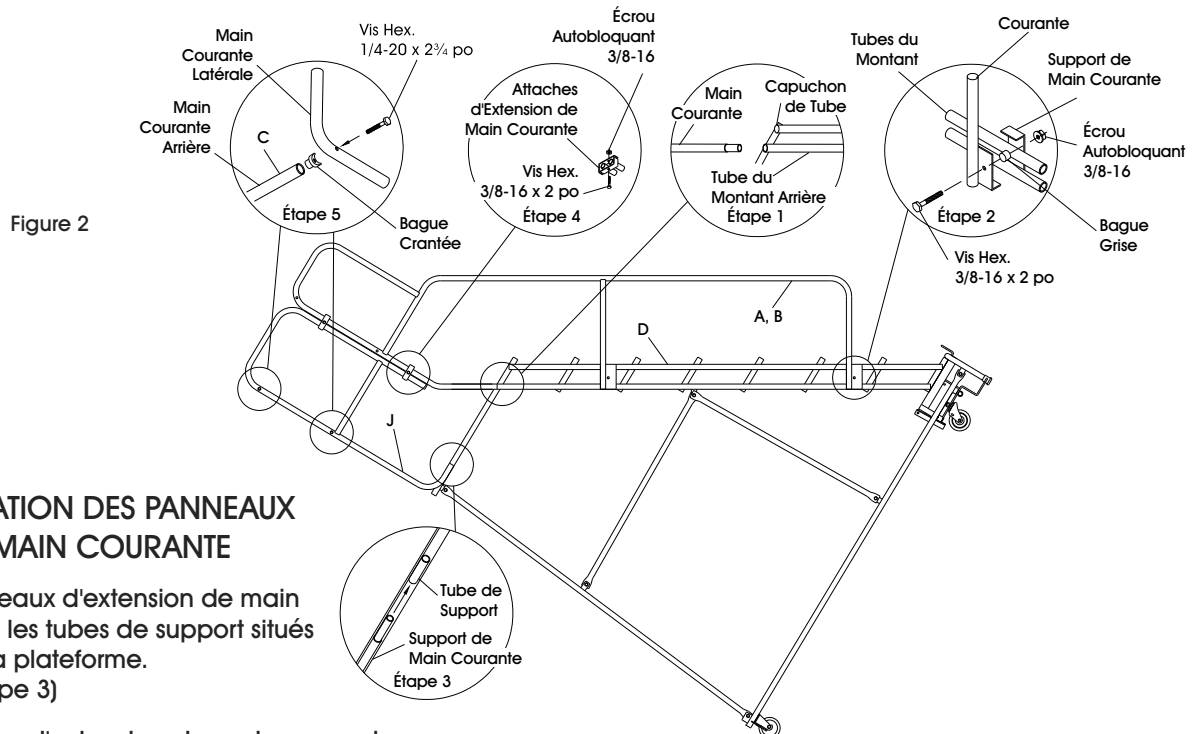

ÉTAPE 4 : INSTALLATION DES PANNEAUX D'EXTENSION DE MAIN COURANTE

- Installez les panneaux d'extension de main courante (J) dans les tubes de support situés sur les côtés de la plateforme. (Voir Figure 2, Étape 3)
- Serrez le panneau d'extension de main courante aux panneaux de main courante à l'aide d'attaches d'extension, de vis d'assemblage à tête hexagonale de 3/8-16 x 2 po et d'écrous autobloquants. (Voir Figure 2, Étape 4)

MONTAGE SUITE

ÉTAPE 5 : INSTALLATION DES BARRES DE MAIN COURANTE ARRIÈRE

1. Détachez la barre de main courante arrière (C) de la main courante ou du panneau d'extension.
2. Insérez la bague crantée dans chaque extrémité des barres de main courante arrière (C).
(Voir Figure 2, Étape 5)
3. Placez les barres de main courante arrière entre les trous de montage sur la partie supérieure des mains courantes latérales, à l'aide de (4) vis d'assemblage à tête hexagonale 1/4-20 x 2³/₄ po.



REMARQUE : Vous pouvez maintenant serrer tous les boulons de main courante.

ÉTAPE 6 : MISE AU NIVEAU DE L'ÉCHELLE

1. Placez l'échelle debout sur une surface de niveau.
2. Activez le verrou de sûreté en marchant sur la barre de déclenchement située devant la première marche.
3. Ceci permet la mise au niveau des pattes de l'échelle.
4. Lorsque les marches sont de niveau, serrez tous les boulons installés.



REMARQUE : Ne continuez pas à moins que l'échelle soit stable.

ULINE

1-800-295-5510
uline.ca