

**ULINE H-1230**  
**SLIM JIM**  
**STORAGE SHED**

1-800-295-5510  
uline.com

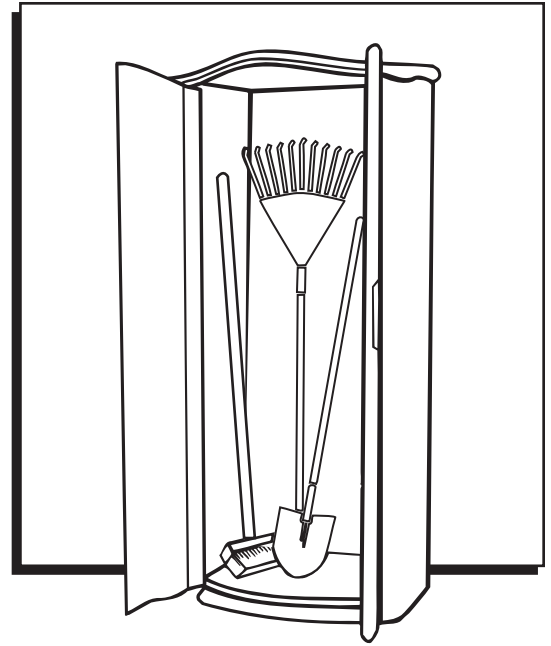

**TOOL RECOMMENDED**



Rubber Mallet

**PARTS**

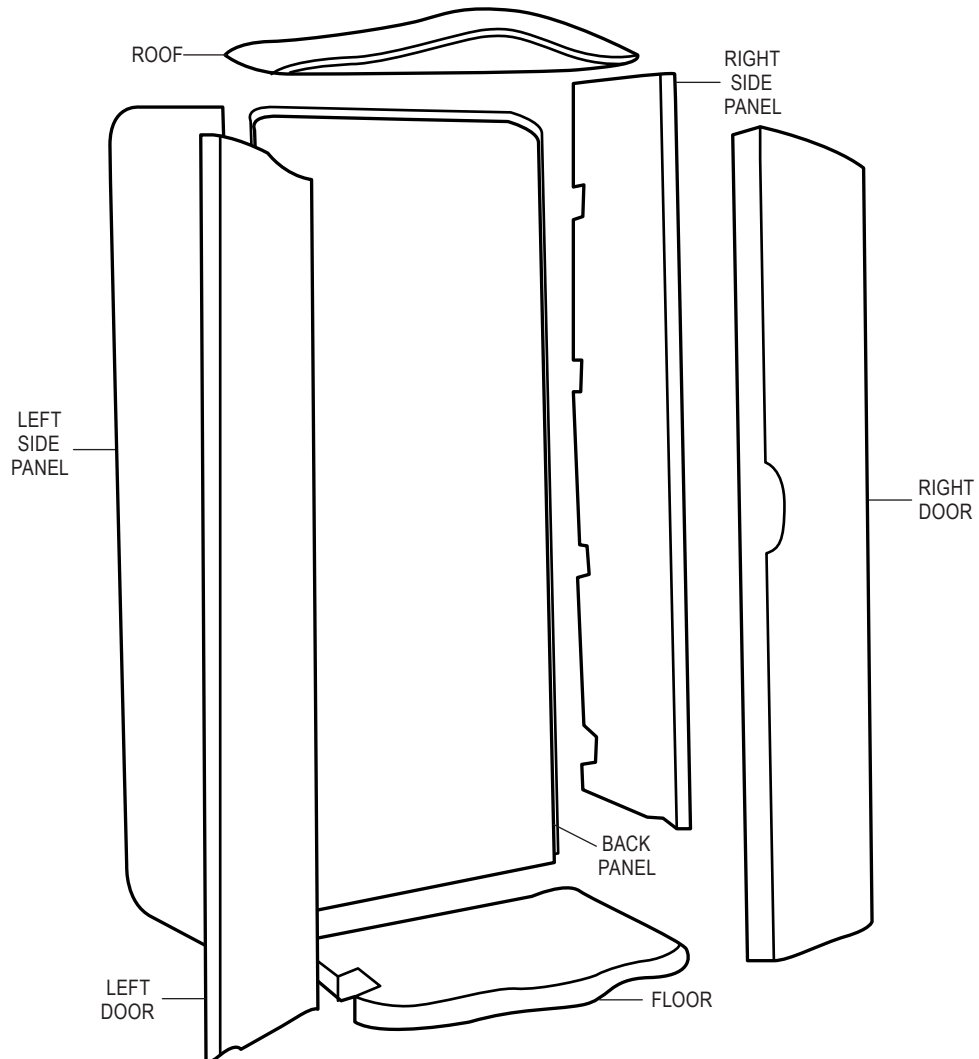

# ASSEMBLY INSTRUCTIONS



**NOTE:** Check that all parts are included in packaging. Names are molded into all parts. Select a site with level ground and good drainage. The door and roof function best when the shed is level.

1. Place the roof and the right side panel on a flat surface. Lift the roof slightly and align the tabs and slots and push the roof down to lock into place.

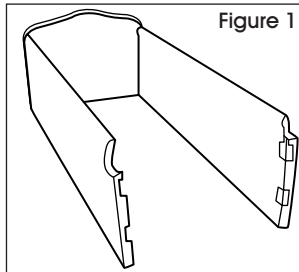

2. Repeat with the left side panel. (See Figure 1)

3. Position the back panel between the side panels with the words "BACK PANEL" facing up. Align the tabs and slots and push the upper back panel toward the roof until it locks into place. (See Figure 2)

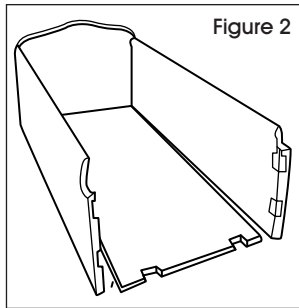

4. Position the floor between the side panels with the word "FLOOR" facing the roof. Align the tabs and slots and push the floor panel down until the tabs on the floor lock into the slots on the back panel. (See Figure 3)

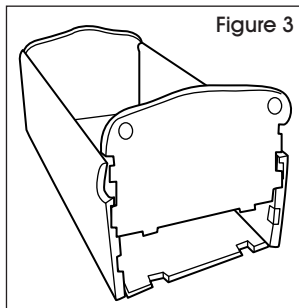

5. Stand the unit upright. Place the right door in the open position and insert the top hinge pin into the upper hinge hole. (See Figure 4)
6. Slide the bottom hinge in toward the bottom hinge hole until it falls into place. Repeat with the left door.
7. Up to four shelves can be added by using standard 3/4" thick lumber cut to fit the molded-in shelf brackets. (See Figure 5)

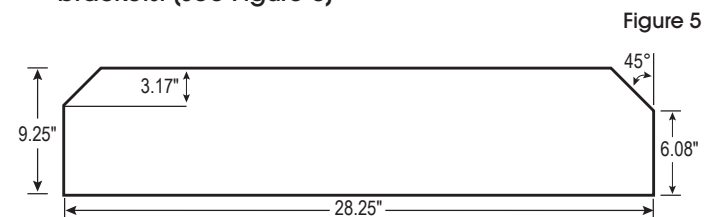
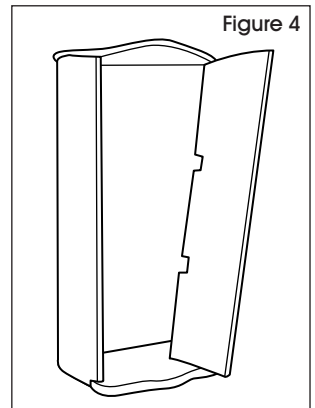

**NOTE:** Insert the shelf with the clip corners facing the back of the shed. Insert the left end of the shelf first, then push the right end into place.

# CARE INSTRUCTIONS

- Periodically inspect the shed to ensure proper assembly is maintained and site remains level.
- Clean shed using garden hose or wash with a mild detergent and water.
- The shed can be secured to any immovable object by drilling through four molded-in recessed areas in the back panel.

- The shed can also be secured by drilling through four floor locations and inserting stakes into the ground.



**CAUTION!** Do not clean with a stiff or abrasive cleaner. Wear safety glasses and follow the manufacturer's instructions when using power tools. Do not store hot yard equipment, grills or other hot materials in the shed.