

# ULINE

## SECURITY CARTS

1-800-295-5510  
uline.com

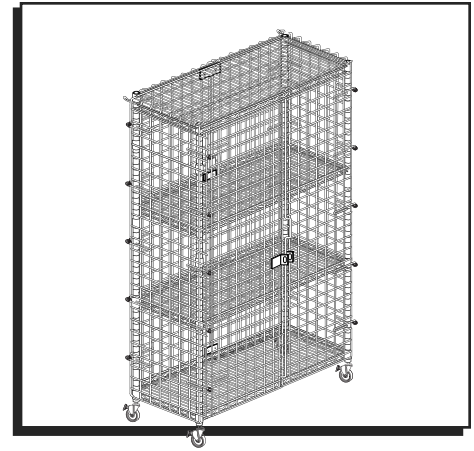

### TOOLS NEEDED



Rubber Mallet

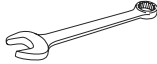

7/16" Wrench

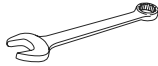

3/8" Wrench

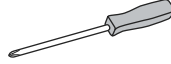

Phillips Head  
Screwdriver

### SHELVING PARTS

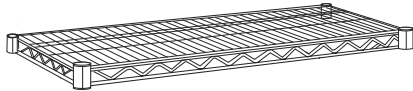

Shelf x 4



Shelf Support x 16 Sets



Caster x 4

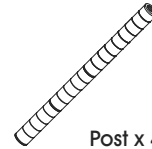

Post x 4

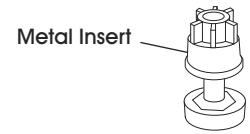

Metal Insert

Self-Leveling Foot x 4



**NOTE:** Shelf supports are included in shelf box.



**NOTE:** Self-leveling feet are included in post box. See Page 3 for installation.

### INSTALLATION OF CASTERS

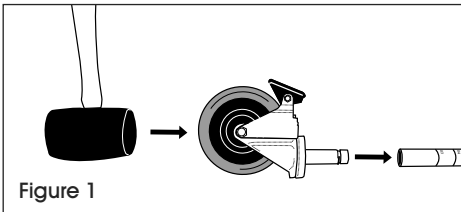

Figure 1

1. Make sure post is positioned as shown. (See Figure 1)
2. Engage the wheel brakes to keep casters from rolling during assembly. Use a rubber mallet to tap caster stems into posts. (See Figure 1)

### SHELVING ASSEMBLY

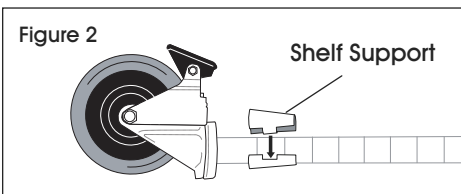

Figure 2

Shelf Support

1. Start with the lowest shelf. Snap the interlocking pieces of a shelf support (wide end down) around the post at the lowest groove where shelf is to be located. (See Figure 2)



**NOTE:** Two ridges are on the inside of each shelf support. The bottom shelf support ridge should be aligned with the lowest groove on the post.

2. Slide the shelf support up or down until it snaps into the groove. Add shelf supports to the same place on the remaining posts.

## SHELVING ASSEMBLY CONTINUED

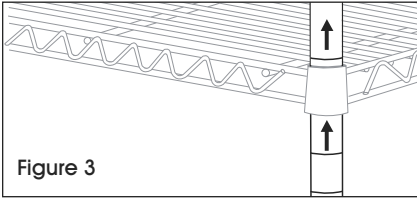

Figure 3

- Slide post through underside of shelf until shelf slides firmly over supports. (See Figure 3)

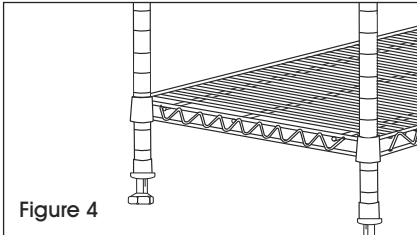

Figure 4

- Stand unit upright. Gently tap shelf down to secure it. (See Figure 4)

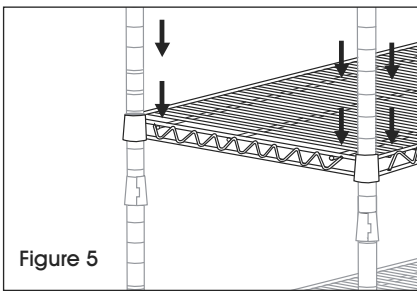
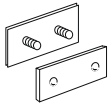

Figure 5

- Determine the height of the next shelf, snap on supports, then add and secure shelf. Repeat to add the remaining shelves. (See Figure 5)

 **NOTE: Top shelf must be placed at top of posts.**

## SECURITY CART PARTS



Back Panel  
Bracket x 4



Large Nut x 8



Bracket x 8



Bolt x 4



Nut x 4

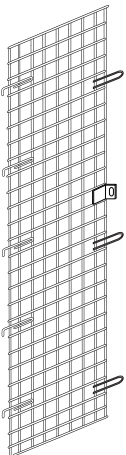

Front Left Door x 1

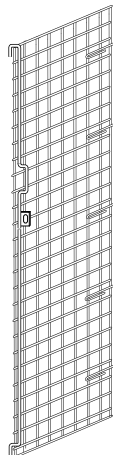

Front Right Door with Latch x 1

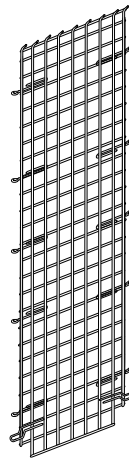

Side Panel x 2

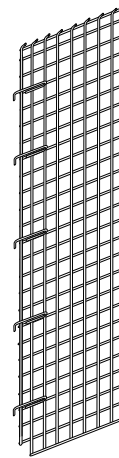

Back Left Panel x 1

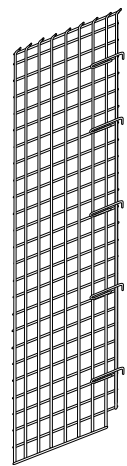

Back Right Panel x 1

 **NOTE: Back panels, side panels, large nuts and back panel brackets are included in the panel box.**

# PANEL ASSEMBLY

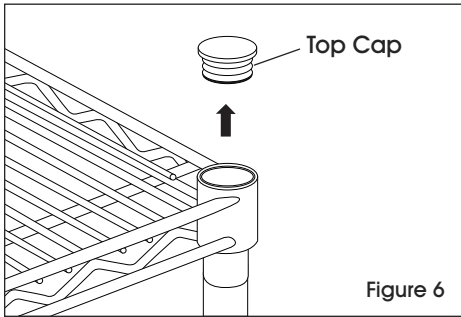

## INSTALLATION OF SELF-LEVELING FEET

1. Remove plastic top caps from all four posts. (See Figure 6)
2. Remove floor protectors and leveling bolts from metal inserts of self-leveling feet located in post boxes. (See Figure 7)
3. Install metal inserts into holes where plastic top caps were. Make sure insert is fully set into top of post. Tap into place with rubber mallet. (See Figure 8)

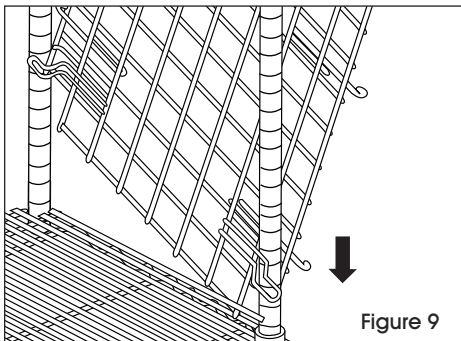
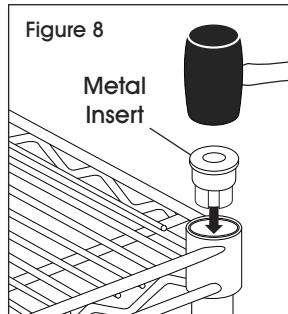
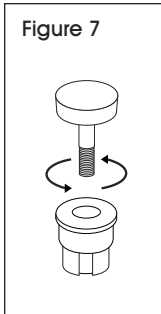

## ATTACH SIDE PANELS

 **NOTE:** Do not screw in bolts until all panels are installed.

1. Assemble side panels with loops on top facing inward. Tilt panel so it locks around posts on both ends, then slide down so loops are on top of the metal insert that was installed at the top of the post. (See Figure 9)
2. Repeat with second side panel.

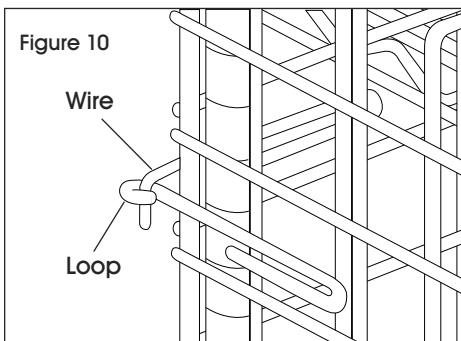

## ATTACH BACK PANELS

1. Assemble back left panel first. Place wires facing downward into loops on side panel. (See Figure 10)
2. Repeat for the back right panel.

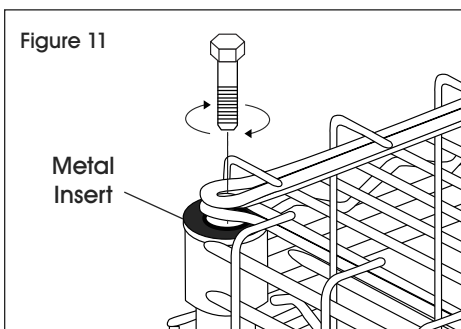

3. After all the loops are aligned on top of the metal inserts on the top of the posts, screw in the bolt on all four posts and tighten using wrench. (See Figure 11)

## PANEL ASSEMBLY CONTINUED

Figure 12

Top Bracket

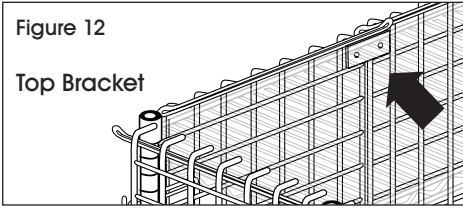

4. Secure back panels with back panel brackets by attaching brackets at top and bottom of the back panels. (See Figures 12-13)

Figure 13

Bottom Bracket

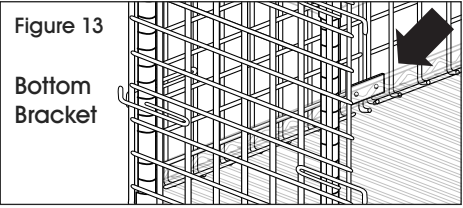
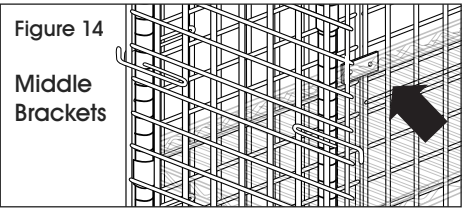

Figure 14

Middle Brackets



5. Space third and fourth brackets evenly in the middle of the back panel. Install brackets through shelves for maximum security. (See Figure 14)

Figure 15

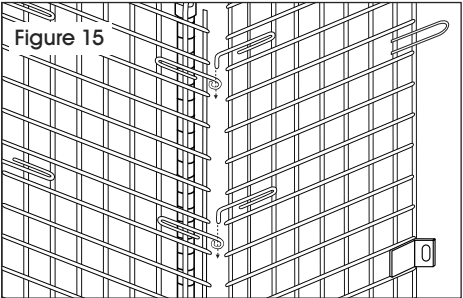

### ATTACH FRONT DOORS

1. Align left front door hinges with side panel hinges and lower door into place. (See Figure 15)
2. Repeat process with right front door.

Figure 16

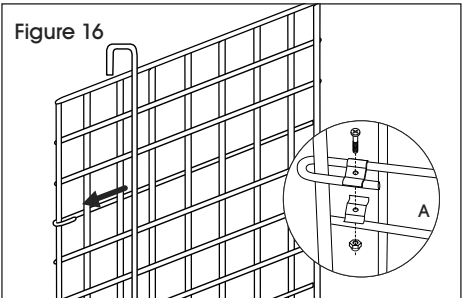

### LATCH FRONT DOORS

1. Slide the handle rod with latch into the U-shape hooks. (See Figure 16)
2. Assemble brackets with one bolt and one nut. (See Figure 16A)
3. To ensure the front doors latch properly, close the left front door first.

Figure 17

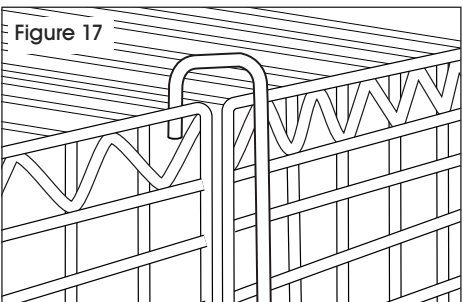

4. Raise the latch and close the right front door. Lower the latch into place to secure door. (See Figure 17)

## PANEL ASSEMBLY CONTINUED

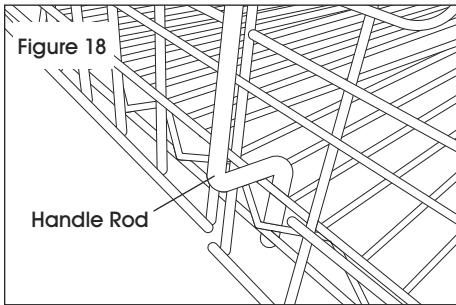

**NOTE:** In order for door to close and latch properly, the handle rod must also go through the bottom shelf. (See Figure 18)

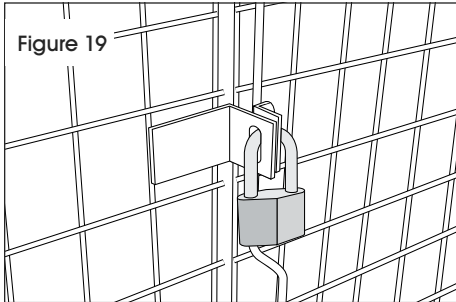

5. A padlock (not included) may be secured to the latch as shown. (See Figure 19)

**ULINE**

1-800-295-5510  
uline.com

**CARRITOS DE SEGURIDAD****HERRAMIENTAS NECESARIAS**

Mazo de Caucho

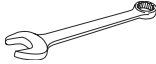

Llave de 7/16"

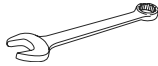

Llave de 3/8"

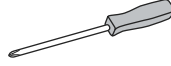

Desarmador de Cruz

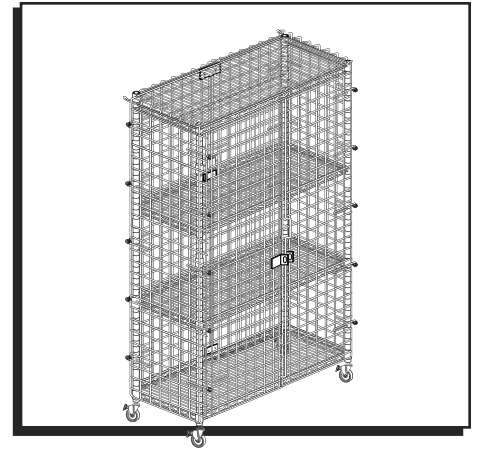
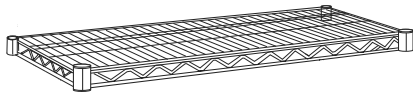
**PARTES DE ESTANTERÍA**

4 Repisas



16 Sets de Soportes para Repisas



4 Ruedas



4 Postes

Inserto de Metal

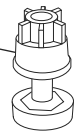

4 Patas Autoniveladoras



**NOTA:** Los soportes para repisas están incluidos en la caja de las repisas.



**NOTA:** Las patas autoniveladoras están incluidas en la caja de los postes. Vea la Página 7 para la instalación.

**INSTALACIÓN DE LAS RUEDAS**

Diagrama 1

1. Asegúrese de que el poste esté posicionado como se muestra. (Vea Diagrama 1)
2. Ponga los seguros de las ruedas para evitar que giren durante el ensamble. Utilice un mazo de caucho para insertar los vástagos de las ruedas en su lugar. (Vea Diagrama 1)

**ENSAMBLE DE ESTANTERÍA**

Diagrama 2

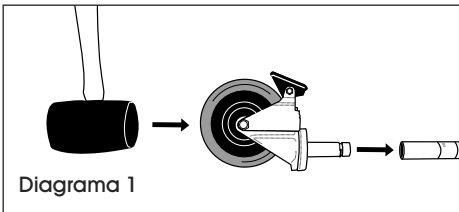
Soporte para Repisa

1. Comience con la repisa inferior. Embone las piezas del soporte para repisa (con la parte ancha hacia abajo) alrededor del poste en la ranura más baja donde se ubicará la repisa. (Vea Diagrama 2)

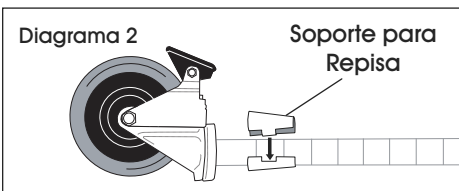

**NOTA:** Hay dos muescas en el interior de cada soporte para repisa. La muesca del soporte para repisa inferior se debe alinear con la ranura más baja del poste.

2. Deslice el soporte hacia arriba o abajo hasta que se trabe en la ranura. Agregue los soportes para repisa a la misma altura en los postes restantes.

## CONTINUACIÓN DE ENSAMBLE DE ESTANTERÍA

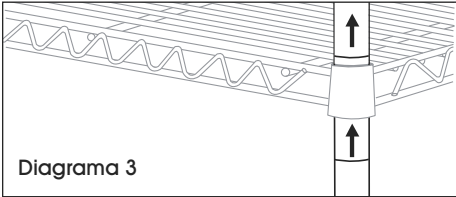

3. Deslice los postes a través de la parte inferior de la repisa hasta que la misma se deslice firmemente sobre los soportes. (Vea Diagrama 3)

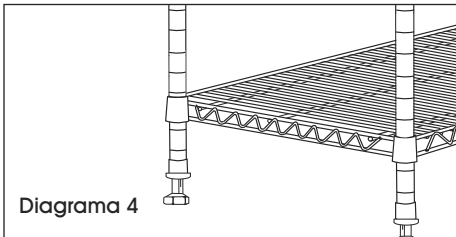

4. Coloque la unidad en posición vertical. Golpee ligeramente la repisa para asegurarla. (Vea Diagrama 4)

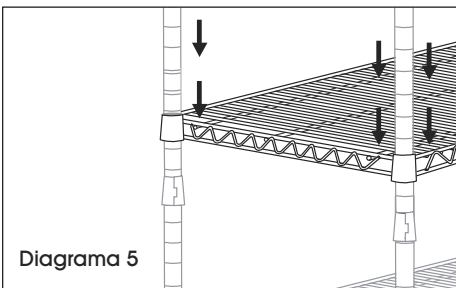

5. Determine la altura de la siguiente repisa, inserte a presión los soportes y después agregue y asegure la repisa. Repita para agregar las repisas restantes. (Vea Diagrama 5)



**NOTA:** La repisa superior se debe colocar en la parte más alta de los postes.

## PARTES DE CARRITO DE SEGURIDAD

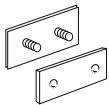

4 Abrazaderas para Panel Posterior



8 Tuercas Grandes



8 Abrazaderas



4 Pernos



4 Tuercas

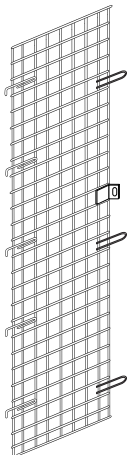

1 Puerta Frontal Izquierda

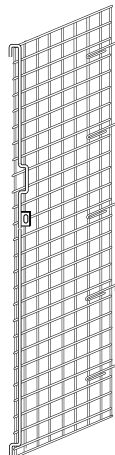

1 Puerta Frontal Derecha con Pasador

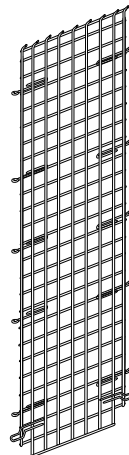

2 Paneles Laterales

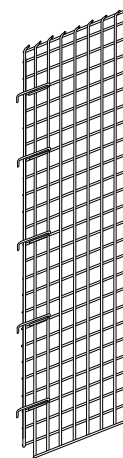

1 Panel Posterior Izquierdo

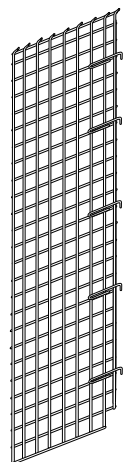

1 Panel Posterior Derecho



**NOTA:** Los paneles posteriores, paneles laterales, tuercas grandes y abrazaderas para paneles posteriores están incluidos en la caja de los paneles.



# ENSAMBLE DE LOS PANELES

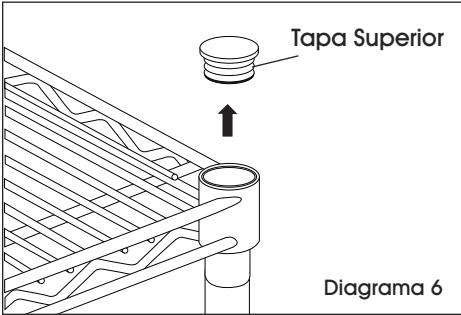

## INSTALACIÓN DE LAS PATAS AUTONIVELADORAS

1. Retire las tapas de plástico superiores de los cuatro postes. (Vea Diagrama 6)

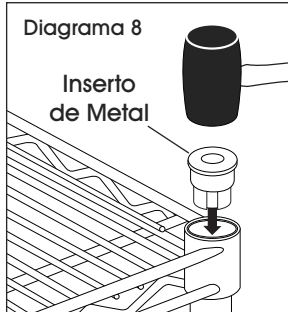
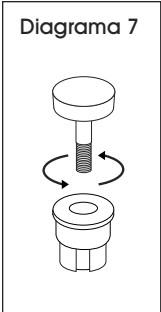

2. Retire los protectores para piso y pernos de nivelación de los insertos de metal de las patas autoniveladoras localizadas en las cajas de los postes. (Vea Diagrama 7)
3. Instale los insertos de metal en los orificios donde estaban las tapas de plástico. Asegúrese de que el inserto esté completamente dentro de la parte superior del poste. Colóquelo en su lugar con el mazo de caucho. (Vea Diagrama 8)

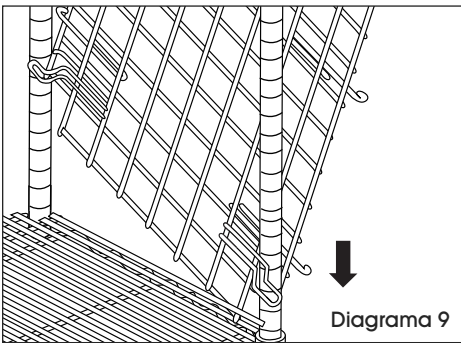

## FIJAR LOS PANELES LATERALES

 **NOTA:** No atornille los pernos hasta que todos los paneles estén instalados.

1. Ensamble los paneles laterales con las presillas superiores hacia adentro. Incline el panel de modo que asegure en ambos extremos, luego deslícelo hacia abajo de modo que las presillas queden sobre el inserto de metal instalado en la parte superior del poste. (Vea Diagrama 9)
2. Repita con el segundo panel lateral.

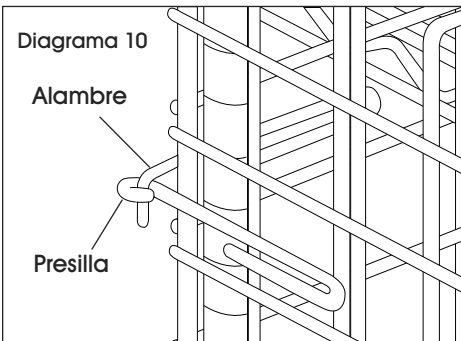

## FIJAR LOS PANELES POSTERIORES

1. Ensamble el panel posterior izquierdo. Coloque los alambres hacia abajo dentro de las presillas en el panel lateral. (Vea Diagrama 10)
2. Repita con panel posterior derecho.

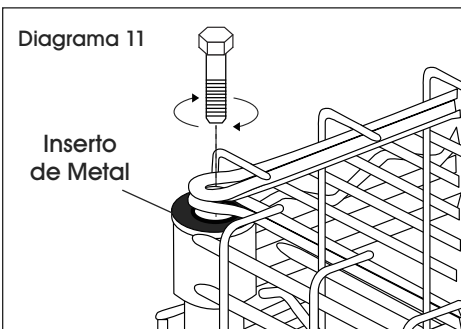

3. Después de que las presillas estén alineadas sobre los insertos de metal en la parte superior de los postes, atornille los pernos en todos los cuatro postes y apriételos usando la llave. (Vea Diagrama 11)



## CONTINUACIÓN DEL ENSAMBLE DE LOS PANELES

Diagrama 12

Abrazadera Superior

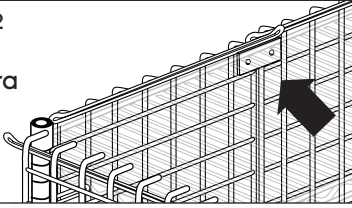

4. Asegure los paneles posteriores con abrazaderas de panel posterior fijando las abrazaderas en la parte superior e inferior de los paneles posteriores. (Vea Diagramas 12-13)

Diagrama 13

Abrazadera Inferior

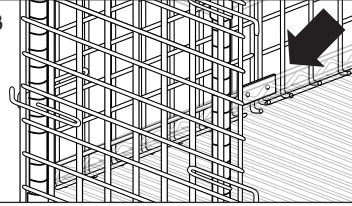

5. Separe las terceras y cuartas abrazaderas de manera uniforme en medio del panel posterior. Instale las abrazaderas a través de las repisas para máxima seguridad. (Vea Diagrama 14)

Diagrama 14

Abrazaderas Intermedias



Diagrama 15



### FIJAR LAS PUERTAS FRONTALES

1. Alinee las bisagras de las puertas frontales izquierdas y baje la puerta a su lugar. (Vea Diagrama 15)
2. Repita el proceso con la puerta frontal derecha.

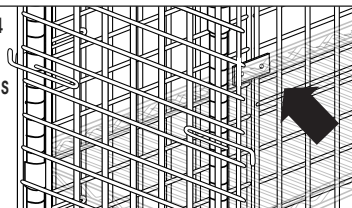
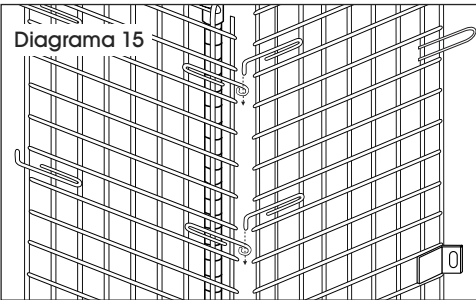
Diagrama 16

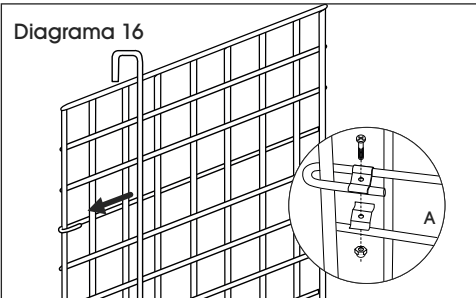

### CERRAR LAS PUERTAS FRONTALES CON PASADOR

1. Deslice la varilla del asa con pasador por los ganchos en U. (Vea Diagrama 16)
2. Ensamble las abrazaderas con un perno y una tuerca. (Vea Diagrama 16A)
3. Para asegurarse de que las puertas frontales se cierren con el pasador, cierre la puerta frontal izquierda primero.

Diagrama 17

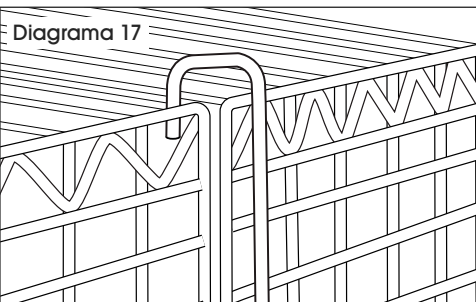

4. Levante el pasador y cierre la puerta frontal derecha. Baje el pasador a su lugar para asegurar la puerta. (Vea Diagrama 17)

## CONTINUACIÓN DEL ENSAMBLE DE LOS PANELES

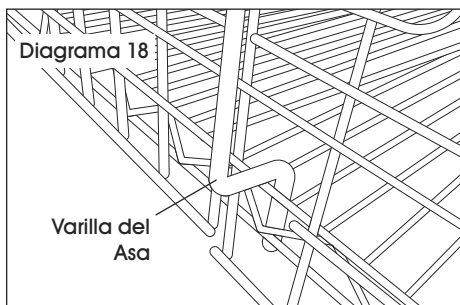

**NOTA:** Para cerrar bien la puerta con el pasador, la varilla del asa también debe pasar por la repisa inferior. (Vea Diagrama 18)

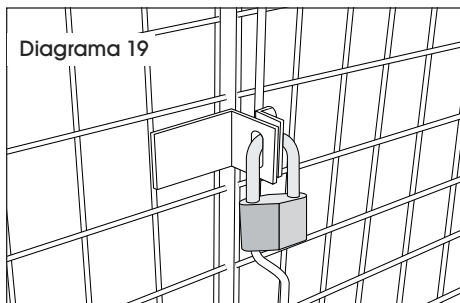

5. Puede colocar un candado (no incluido) en el pasador como se muestra. (Vea Diagrama 19)

**ULINE**

800-295-5510  
uline.mx

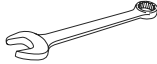
**CHARIOTS  
DE SÉCURITÉ****OUTILS REQUIS**Maillet en  
caoutchouc

Clé de 7/16 po

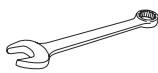

Clé de 3/8 po

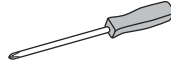
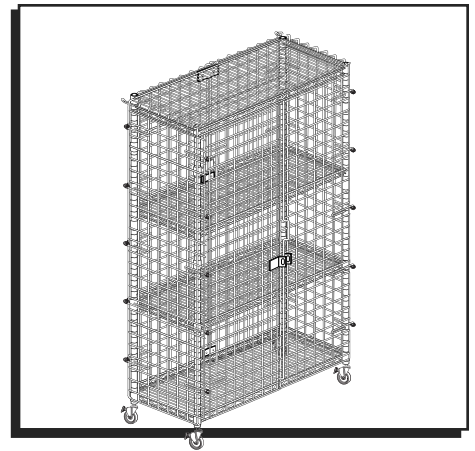
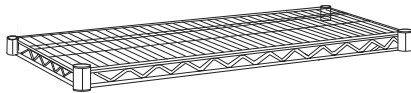
Tournevis  
cruciforme**PIÈCES DE L'UNITÉ DE RAYONNAGE**

Tablette x 4

Support de tablette  
x 16 ensembles

Roulette x 4

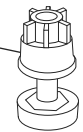

Montant x 4

Manchon  
en métal

Pied autonivelant x 4



**REMARQUE :** Les supports de tablette sont inclus dans la boîte des tablettes.



**REMARQUE :** Les pieds autonivelants sont inclus dans la boîte des montants. Consultez la page 11 pour les consignes d'installation.

**INSTALLATION DES ROULETTES**

Figure 1

1. Assurez-vous que le montant est positionné comme illustré. (Voir Figure 1)
2. Actionnez le frein des roues pour empêcher le mouvement des roulettes lors du montage. Utilisez un maillet en caoutchouc pour tapoter la tige des roulettes dans les montants. (Voir Figure 1)

**MONTAGE DE L'UNITÉ DE RAYONNAGE**

Figure 2

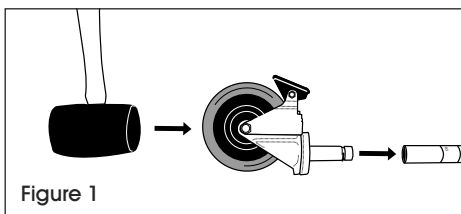
Support de  
tablette

1. Commencez par la tablette la plus basse. Enclenchez les deux parties d'un support de tablette (la partie la plus large vers le bas) autour du montant à la rainure la plus basse où la tablette doit être placée. (Voir Figure 2)

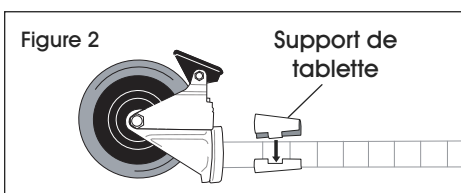

**REMARQUE :** Il y a deux rayures à l'intérieur de chaque support de tablette. La rayure inférieure du support de tablette doit être alignée avec la rainure la plus basse sur le montant.

2. Faites glisser le support vers le haut ou vers le bas jusqu'à ce qu'il s'enclenche dans la rainure. Ajoutez un support de tablette au même endroit sur les montants restants.

## MONTAGE DE L'UNITÉ DE RAYONNAGE SUITE

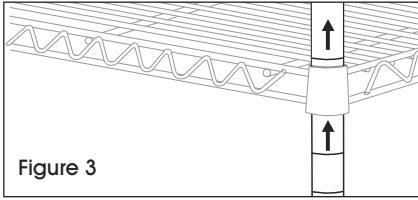

Figure 3

- Faites glisser le montant sous la partie inférieure de la tablette jusqu'à ce que la tablette se fixe fermement en place sur les supports. (Voir Figure 3)

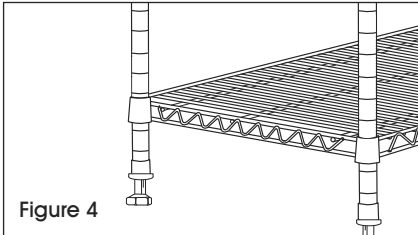

Figure 4

- Placez l'unité à l'endroit. Tapotez doucement la tablette vers le bas pour la fixer. (Voir Figure 4)

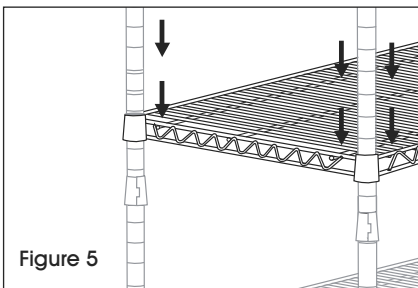

Figure 5

- Déterminez la hauteur de la tablette suivante, installez les supports de tablette, puis ajoutez et fixez la tablette. Répétez pour installer les tablettes restantes (Voir Figure 5)



**REMARQUE :** La tablette supérieure devrait être installée au-dessus des montants.

## PIÈCES DU CHARIOT DE SÉCURITÉ

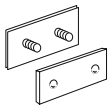

Support pour  
panneau arrière x 4



Gros écrou x 8



Support x 8



Boulon x 4



Écrou x 4

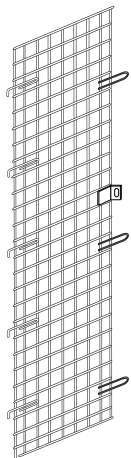

Porte avant  
gauche x 1

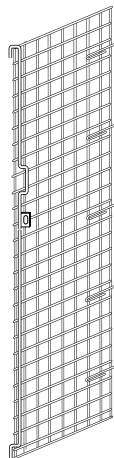

Porte avant droite  
avec loquet x 1

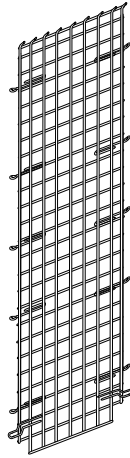

Panneau  
latéral x 2

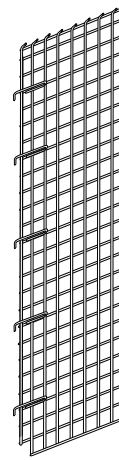

Panneau arrière  
gauche x 1

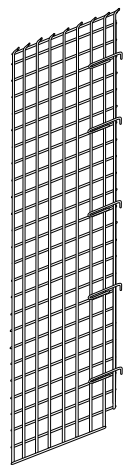

Panneau arrière  
droit x 1



**REMARQUE :** Les panneaux arrière et latéraux, les gros écrous et les supports pour panneau arrière sont inclus dans la boîte des panneaux.

# MONTAGE DES PANNEAUX

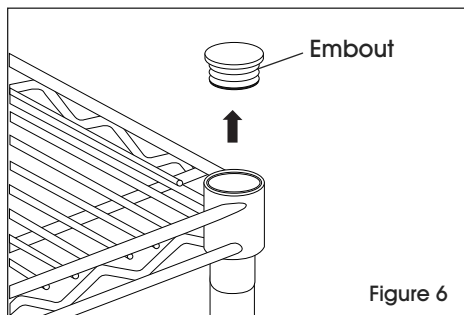

## INSTALLATION DES PIEDS AUTONIVELANTS

1. Enlevez les embouts en plastique des quatre montants. (Voir Figure 6)

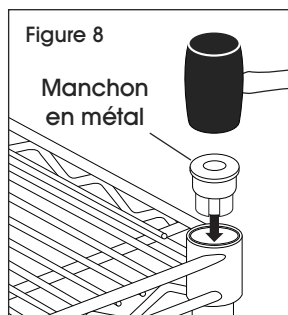
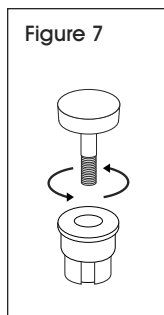

2. Enlevez les protecteurs de plancher et les boulons de nivellement qui se trouvent sur les manchons en métal des pieds autonivelants situés dans la boîte des montants. (Voir Figure 7)
3. Insérez les manchons en métal dans les trous où se trouvaient les embouts en plastique. Assurez vous que le manchon est inséré complètement dans le dessus du montant. Tapotez avec un maillet en caoutchouc pour fixer en place. (Voir Figure 8)

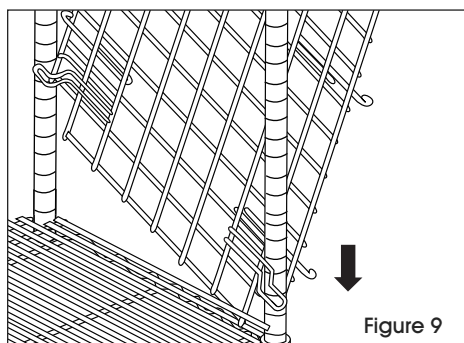

## FIXATION DES PANNEAUX LATÉRAUX



**REMARQUE :** Ne vissez pas les boulons avant que tous les panneaux ne soient installés.

1. Montez les panneaux latéraux en vous assurant que les boucles du haut sont orientées vers l'intérieur. Inclinez le panneau pour qu'il se fixe autour des montants des deux côtés, puis glissez-le vers le bas de façon à ce que les boucles se retrouvent au-dessus du manchon en métal qui était installé au dessus du montant. (Voir Figure 9)
2. Répétez la procédure pour l'autre panneau latéral.

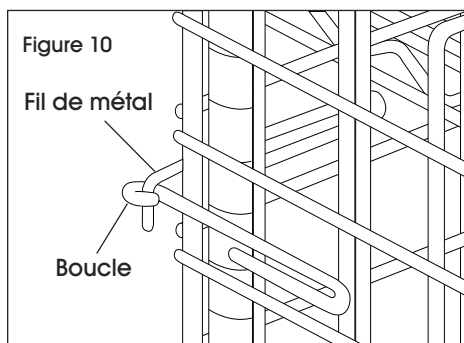

## FIXATION DES PANNEAUX ARRIÈRE

1. Montez le panneau arrière gauche en premier. Placez les fils en métal orientés vers le bas dans les boucles du panneau latéral. (Voir Figure 10)
2. Répétez la procédure pour le panneau arrière droit.

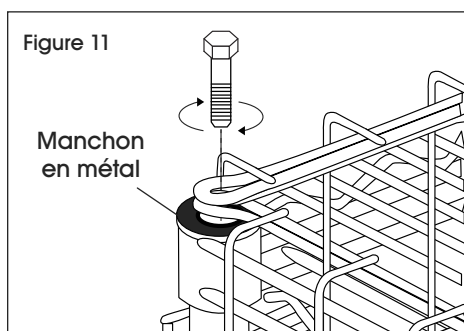

3. Lorsque toutes les boucles sont alignées sur le dessus des manchons en métal au-dessus des montants, vissez le boulon sur les quatre montants, puis serrez à l'aide d'une clé. (Voir Figure 11)

## MONTAGE DES PANNEAUX SUITE

Figure 12

Support  
supérieur

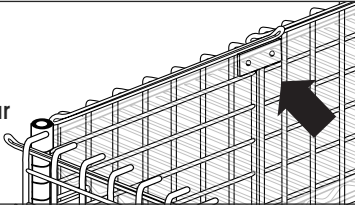

Figure 13

Support  
inférieur

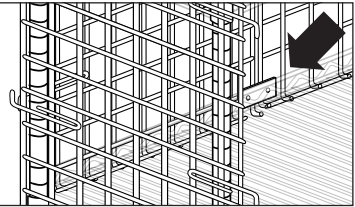
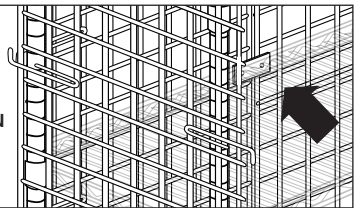

Figure 14

Supports  
du milieu



4. Fixez les panneaux arrière aux supports pour panneau arrière en fixant les supports au haut et au bas des panneaux arrière. (Voir Figures 12 et 13)

5. Espacez le troisième et le quatrième support uniformément au milieu du panneau arrière. Installez les supports dans les tablettes pour assurer une sécurité maximale. (Voir Figure 14)

Figure 15

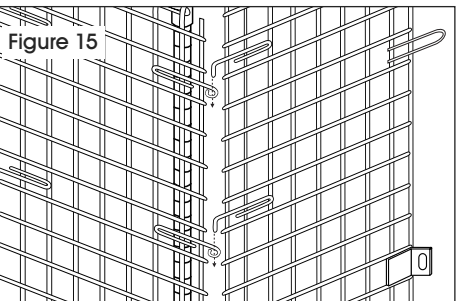

### INSTALLATION DES PORTES AVANT

1. Alignez les charnières de la porte avant gauche avec les charnières du panneau latéral et abaissez la porte pour la mettre en place. (Voir Figure 15)
2. Répétez la procédure avec la porte avant droite.

Figure 16

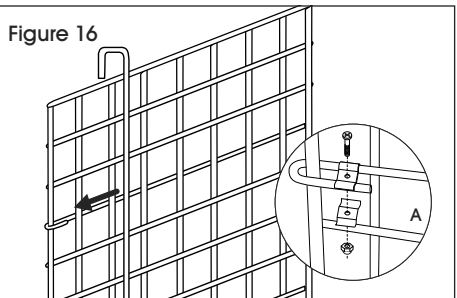

### PORTES AVANT AVEC LOQUET

1. Faites glisser la tige de poignée avec loquet dans les crochets en U. (Voir Figure 16)
2. Fixez les supports à l'aide d'un boulon et d'un écrou. (Voir Figure 16A)
3. Pour vous assurer que les portes avant se ferment correctement, fermez la porte avant gauche en premier.
4. Soulevez le loquet et fermez la porte avant droite. Abaissez le loquet en place pour sécuriser la porte. (Voir Figure 17)

Figure 17

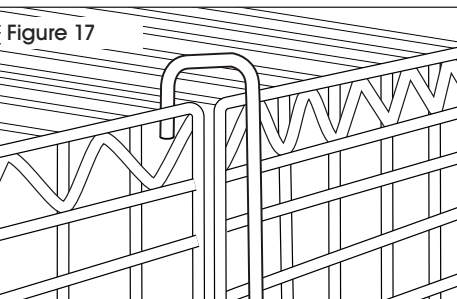

## MONTAGE DES PANNEAUX SUITE

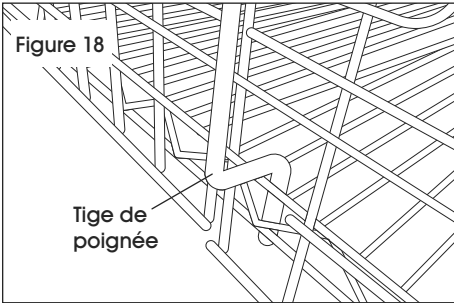

**REMARQUE :** Pour permettre à la porte avant de se fermer et de se verrouiller correctement, la tige de poignée doit également passer à travers la tablette inférieure. (Voir Figure 18)

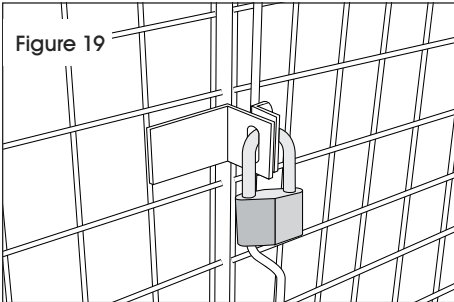

5. Un cadenas (non compris) peut être fixé au loquet comme illustré. (Voir Figure 19)

**ULINE**

1-800-295-5510  
uline.ca