

# ULINE H-2307

## GYM WIPES DISPENSER

1-800-295-5510  
uline.com

### TOOLS NEEDED



Drill



Drill Bit

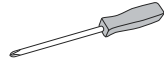

Phillips Screwdriver



Level

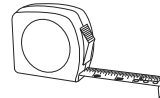

Tape Measure

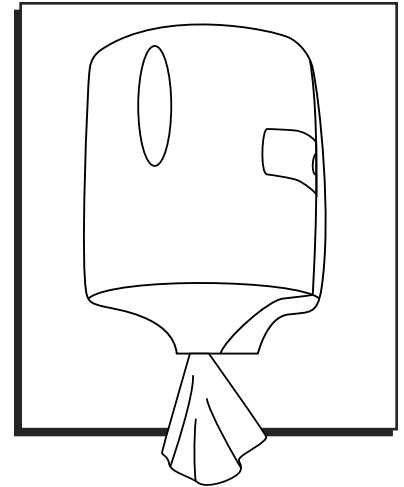

### PARTS

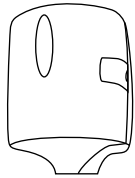

Dispenser x 1

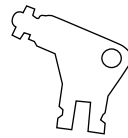

Key x 1

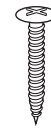

Screw x 4



Wall Anchor x 4

### MOUNTING INSTRUCTIONS

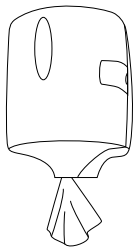

CAN BE  
MOUNTED  
INVERTED

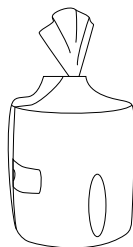

**NOTE:** When mounting for use with dry wipes, the dispensers should be oriented with the opening on the bottom. When mounting for use with gym wipes, the dispensers should be oriented with the opening on the top.



**NOTE:** Recommended mounting height is 48" from the floor to bottom of dispenser.



**NOTE:** Ensure that proper mounting hardware is used for appropriate wall composition as enclosed hardware may not be compatible with your wall surface.

1. Insert the key into the lock on the side of dispenser and turn clockwise to open cover. (See Figure 1)

Figure 1

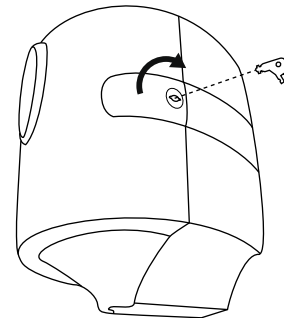

2. Open dispenser cover and hold dispenser to ideal mounting place on wall. (See Figure 2)

Figure 2

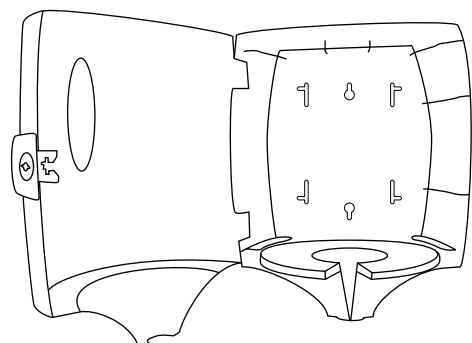

## MOUNTING INSTRUCTIONS CONTINUED

3. Mark the four holes on the wall where screws will be inserted. (See Figure 3)

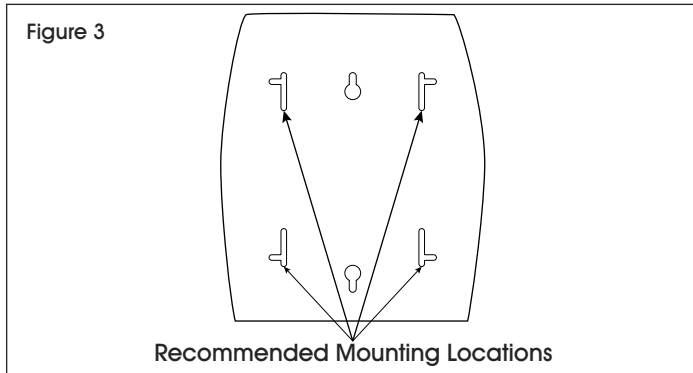

4. Drill into wall at four marked locations with an appropriate drill bit. (See Figure 4) Insert wall anchors if necessary.

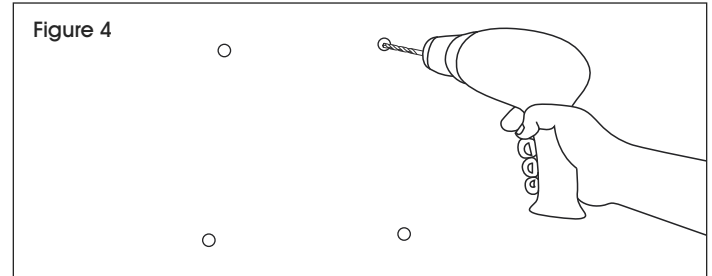

5. Hold dispenser over previously drilled holes and insert screws.

## DISPENSER SETTINGS

 **NOTE:** This dispenser is designed to accommodate thin towels and heavy duty wipers.

1. Before loading product, review which setting the dispenser opening displays. "0" should be for thick wipers. "6" should be for thin paper. (See Figure 5)

 **NOTE:** If towels are too easy to pull, decrease the dial setting.

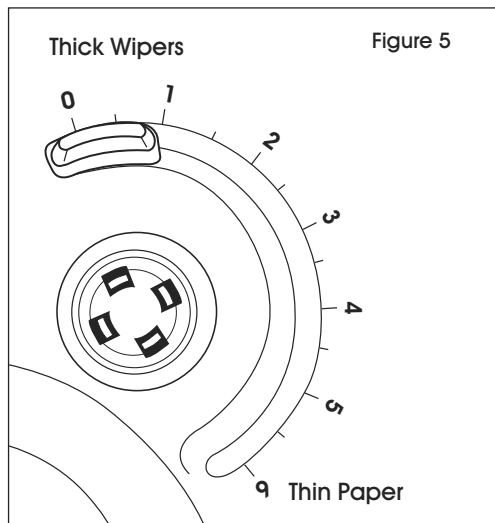

2. To adjust the dial, use dispenser key. Place the key into the four-pronged circle with pointed end facing in. The key should fit between two of the prongs. (See Figure 6)

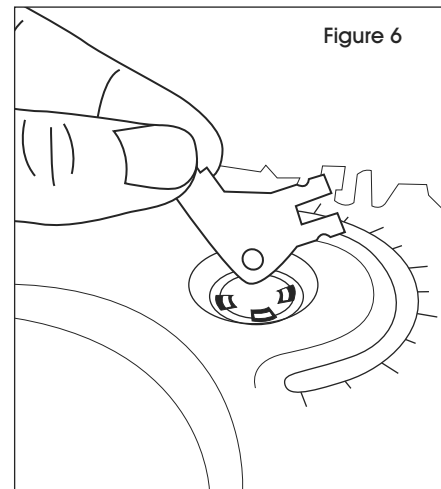

3. Twist the key firmly to desired setting. Twisting the key clockwise will increase the number, while counterclockwise will decrease.

## LOADING DRY WIPERS

1. Begin a new wiper roll by grabbing leading edge of wiper from center and gently pulling out. (See Figure 7)

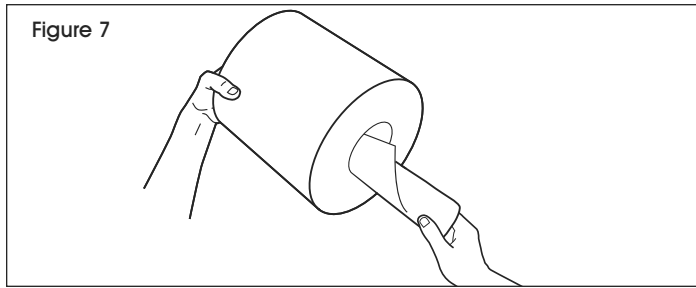

2. Insert key and turn clockwise to open cover.

3. Slip wiper down through dispenser opening. (See Figure 8)

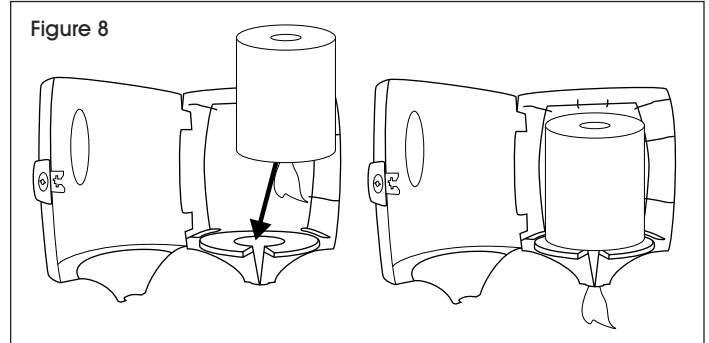

4. Close cover and pull wiper to begin dispensing.

## LOADING GYM WIPES

 **NOTE:** Ensure dispenser is mounted upside down so opening faces up. (See Figure 9)

1. Insert key and turn clockwise to open dispenser. (See Figure 9)

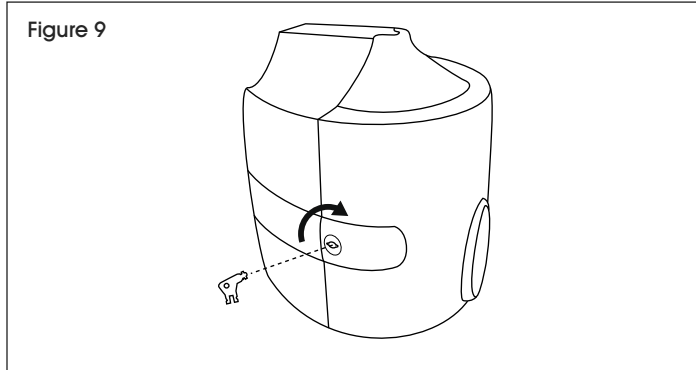

2. Before opening, cut a small v-shaped hole in the top of the bag of pre-moistened wipes and keep wipes inside bag. (See Figure 10)
3. Place the bag of wipes inside the dispenser with the cut hole facing up. Feed wiper through opening to begin dispensing. (See Figure 10)

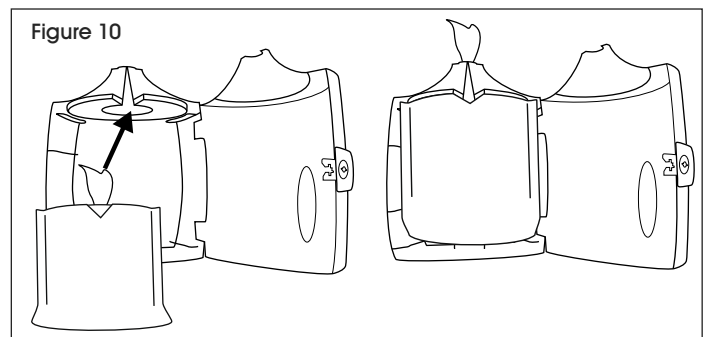

4. Close cover.

**ULINE**

1-800-295-5510  
uline.com

**HERRAMIENTAS NECESARIAS**

Taladro

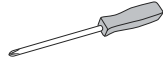
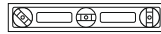

Broca

Desarmador  
de Cruz

Nivel

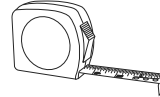
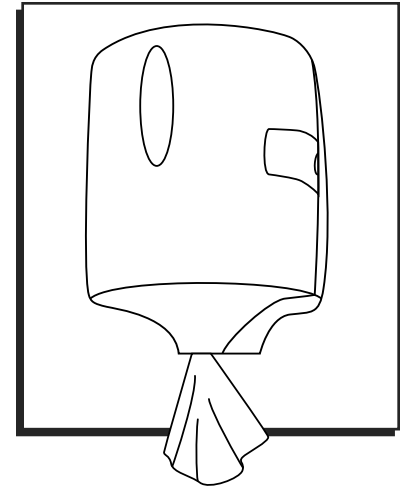
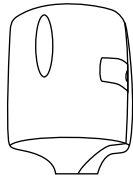
Cinta  
de Medir**PARTES**

1 Despachador



1 Llave

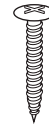

4 Tornillos

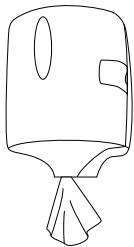
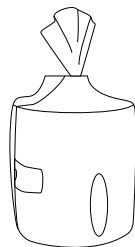

4 Taquetes

**INSTRUCCIONES DE INSTALACIÓN****PUEDEN  
INSTALARSE  
DE FORMA  
INVERTIDA**

**NOTA:** Si se instala para usarse con toallas limpiadoras secas, los despachadores se deben orientar con la abertura hacia abajo. Si se instala para usarse con toallitas para gimnasio, los despachadores se deben orientar con la abertura hacia arriba.



**NOTA:** Se recomienda que la altura de instalación sea de 122 cm (48") del piso a la parte inferior del despachador.



**NOTA:** Asegúrese que se use la tornillería de instalación adecuada según la composición de la pared ya que es posible que la tornillería incluida no sea compatible con la superficie de su pared.

1. Inserte la llave en la cerradura a un lado del despachador y gire en el sentido de las manecillas del reloj para abrir la cubierta. (Vea Diagrama 1)

Diagrama 1

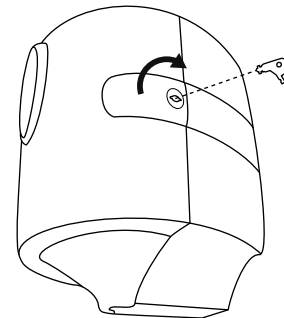

2. Abra la cubierta del despachador y sosténgalo en el lugar ideal de instalación en la pared. (Vea Diagrama 2)

Diagrama 2

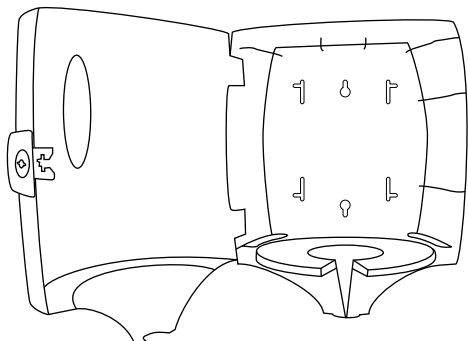

## CONTINUACIÓN DE INSTRUCCIONES DE INSTALACIÓN

3. Marque los cuatro orificios en la pared donde se insertarán los tornillos. (Vea Diagrama 3)

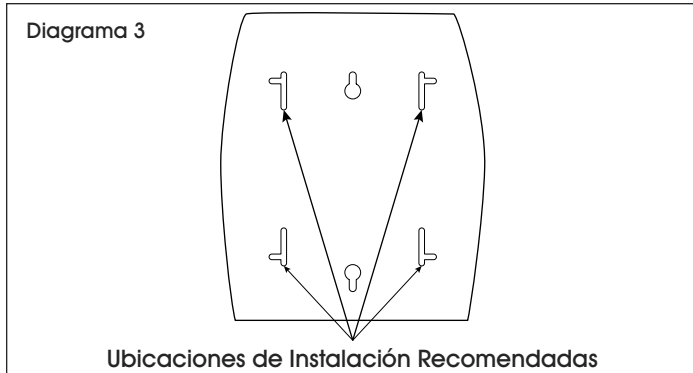

4. Taladre la pared en las cuatro ubicaciones marcadas con una broca adecuada. (Vea Diagrama 4) Inserte los taquetes si fuera necesario.

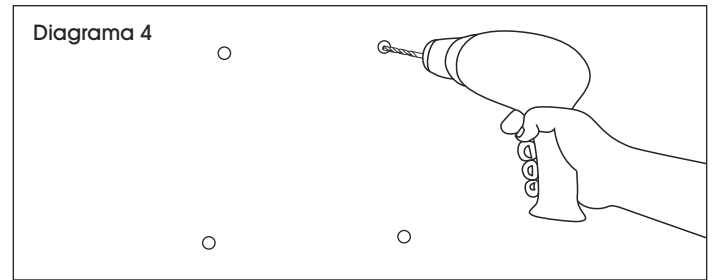

5. Sostenga el despachador sobre los orificios taladrados previamente e inserte los tornillos.

## CONFIGURACIONES DEL DESPACHADOR

 **NOTA:** Este despachador está diseñado para alojar toallitas delgadas y toallas limpiadoras de uso pesado.

1. Antes de cargar el producto, verifique cuál es la configuración que se muestra en la abertura del despachador. "0" debe ser para toallas gruesas. "6" debe ser para papel delgado. (Vea Diagrama 5)

 **NOTA:** Si es muy fácil sacar una toalla, disminuya el ajuste del dial.

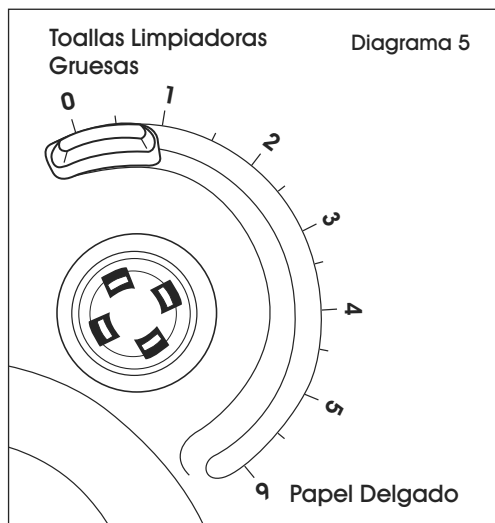

2. Para ajustar el dial, utilice la llave del despachador. Coloque la llave en el círculo de cuatro clavijas con el extremo puntiagudo hacia adentro. La llave debe caber entre dos de las clavijas. (Vea Diagrama 6)

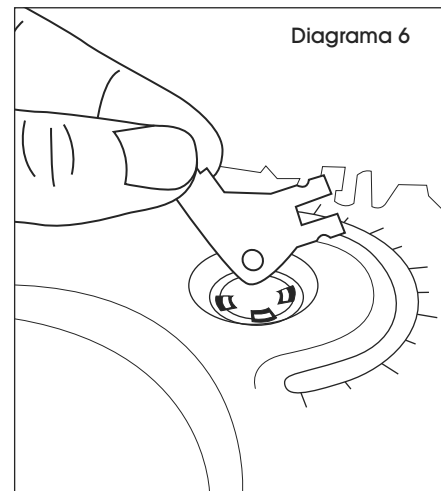

3. Gire la llave de manera firme a la configuración deseada. Girar en el sentido de las manecillas del reloj incrementará el número, mientras que disminuirá si se gira en el sentido contrario de las manecillas del reloj.

## CARGAR TOALLAS LIMPIADORAS SECAS

1. Empiece un rollo nuevo de toallas limpiadoras tomando el borde expuesto de la toalla del centro y ligeramente extrayéndolo. (Vea Diagrama 7)

Diagrama 7

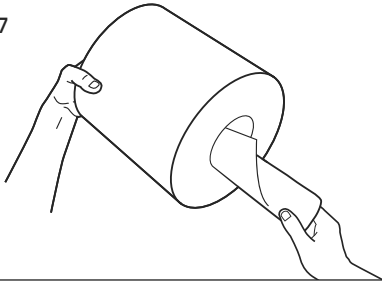

2. Inserte la llave y gire en el sentido de las manecillas del reloj para abrir la cubierta.

3. Deslice la toalla limpiadora hacia abajo por la abertura del despachador. (Vea Diagrama 8)

Diagrama 8

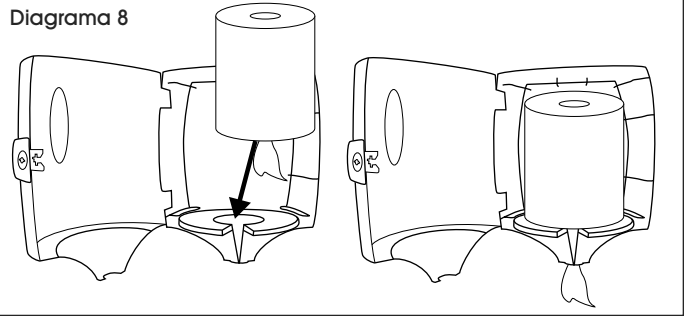

4. Cierre la cubierta y jale la toalla para empezar a despachar.

## CARGAR TOALLITAS PARA GIMNASIO



**NOTA:** Voltee el despachador hacia abajo de forma que el lado de las aberturas quede arriba. (Vea Diagrama 9)

1. Inserte la llave y gírela en el sentido de las manecillas del reloj para abrir la cubierta. (Vea Diagrama 9)

Diagrama 9

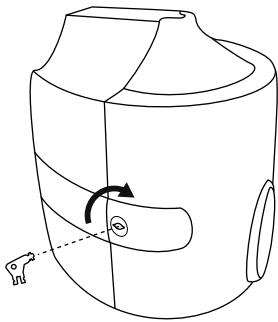

2. Corte una pequeña abertura en la parte superior de la bolsa con las toallitas pre-humedecidas y mantenga las toallitas dentro de la bolsa. (Vea Diagrama 10)
3. Coloque la bolsa de toallitas dentro del despachador. Pase la toalla a través de la abertura para despachar. (Vea Diagrama 10)

Diagrama 10

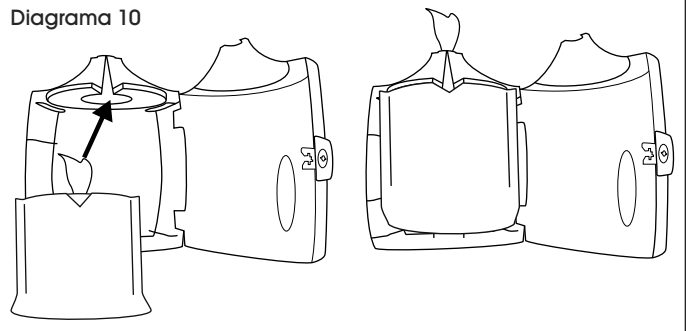

4. Cierre la cubierta.

**ULINE**

800-295-5510  
uline.mx

**ULINE H-2307**

# DISTRIBUTEUR DE LINGETTES POUR GYMNASE

1-800-295-5510

uline.ca

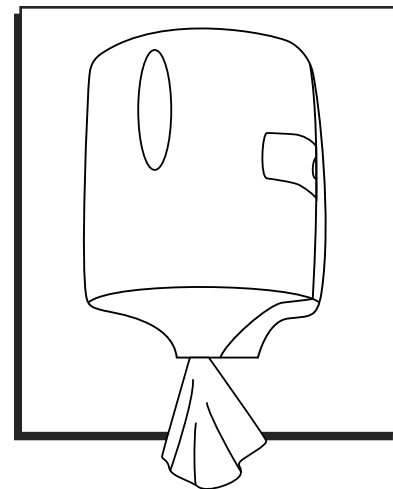

## OUTILS REQUIS



Perceuse



Mèche  
de perceuse

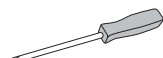

Tournevis  
cruciforme



Niveau à  
bulles

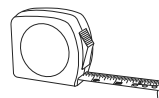

Ruban à  
mesurer

## PIÈCES

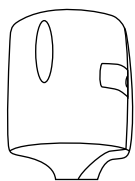

Distributeur x 1

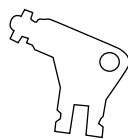

Clé x 1

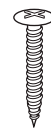

Vis x 4



Ancrage mural x 4

## INSTRUCTIONS DE MONTAGE

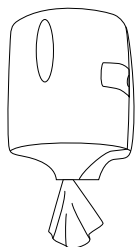

**PEUT  
S'INSTALLER  
DANS  
LE SENS  
INVERSE**

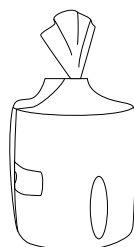

**REMARQUE :** Lors du montage pour une utilisation avec des lingettes sèches, les distributeurs doivent être positionnés avec l'ouverture vers le bas. Lors du montage pour une utilisation avec des lingettes pour gymnase, les distributeurs doivent être positionnés avec l'ouverture vers le haut.



**REMARQUE :** Il est recommandé de fixer le bas du distributeur à une hauteur de 122 cm (48 po) du sol.



**REMARQUE :** Assurez-vous que le matériel d'installation utilisé est adapté à la composition du mur, car le matériel inclus pourrait ne pas être compatible avec la surface de votre mur.

1. Insérez la clé dans le verrou sur le côté du distributeur et tournez-la dans le sens horaire pour ouvrir le couvercle. (Voir Figure 1)

Figure 1

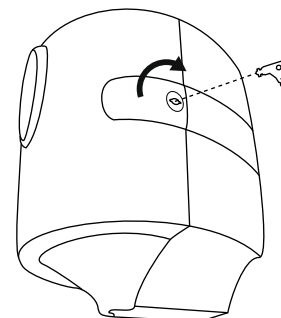

2. Ouvrez le couvercle et maintenez le distributeur à l'emplacement de montage idéal contre le mur. (Voir Figure 2)

Figure 2

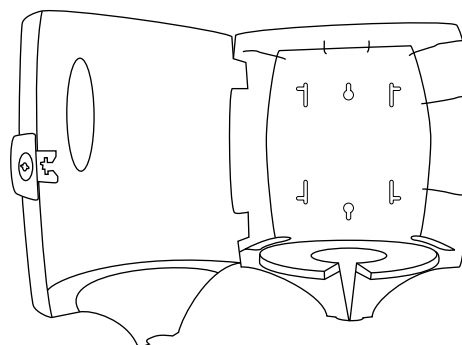

## INSTRUCTIONS DE MONTAGE SUITE

3. Marquez les quatre trous sur le mur où les vis seront insérées. (Voir Figure 3)

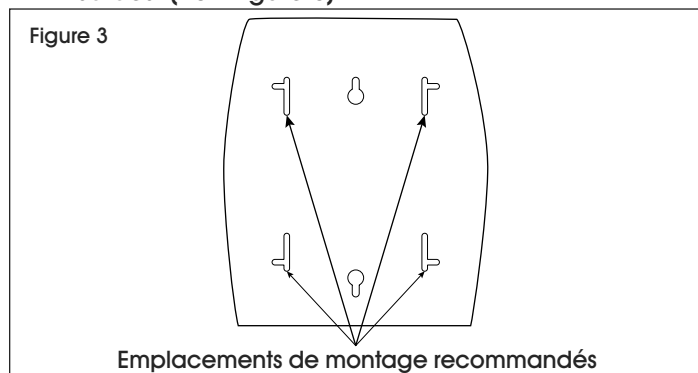

4. Percez le mur aux quatre endroits marqués avec une mèche de perceuse appropriée. (Voir Figure 4) Insérez les ancrages muraux si nécessaire.

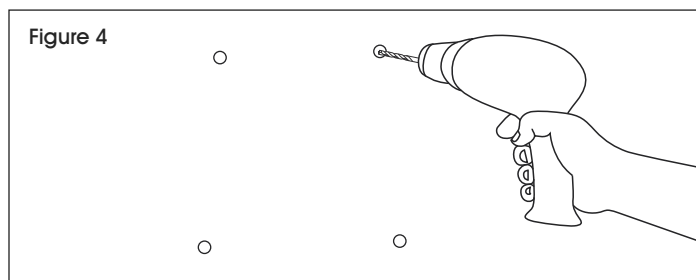

5. Maintenez le distributeur au niveau des trous percés et insérez les vis.

## RÉGLAGES DU DISTRIBUTEUR

 **REMARQUE :** Ce distributeur est conçu pour contenir des serviettes fines et des lingettes nettoyantes robustes.

1. Avant d'y charger le produit, vérifiez quel réglage l'ouverture du distributeur affiche. " 0 " devrait être pour des lingettes épaisses. " 6 " devrait être pour le papier mince. (Voir Figure 5)

 **REMARQUE :** Si les serviettes sont trop faciles à tirer, diminuez la valeur du réglage du cadran.

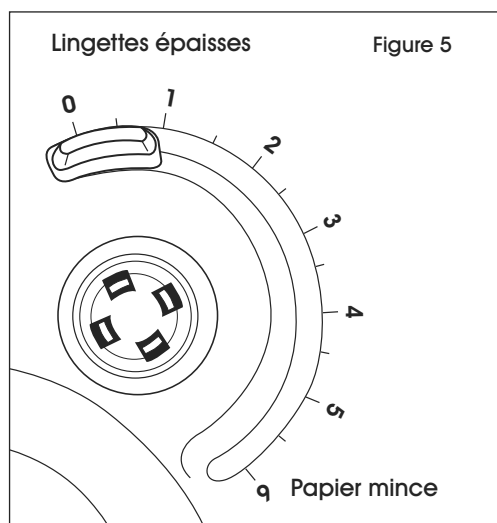

2. Pour ajuster le cadran, utilisez la clé du distributeur. Placez la clé dans le cercle à quatre dents, l'extrémité pointue étant tournée vers l'intérieur. La clé doit s'insérer entre deux des quatre dents. (Voir Figure 6)

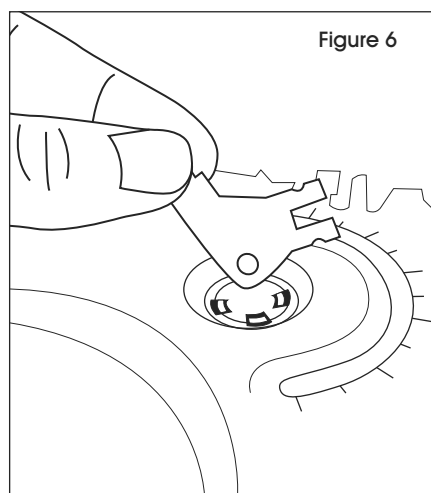

3. Tournez fermement la clé pour obtenir le réglage souhaité. En tournant la clé dans le sens horaire, le nombre augmente, tandis que dans le sens antihoraire, il diminue.



## CHARGEMENT DES LINGETTES SÈCHES

1. Commencez un nouveau rouleau de lingettes en tirant délicatement l'amorce du rouleau par le centre. (Voir Figure 7)

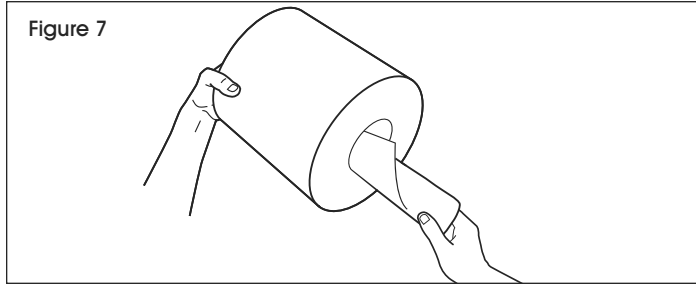

2. Insérez la clé et tournez dans le sens horaire pour ouvrir le couvercle.

3. Faites passer la lingette par l'ouverture du distributeur. (Voir Figure 8)

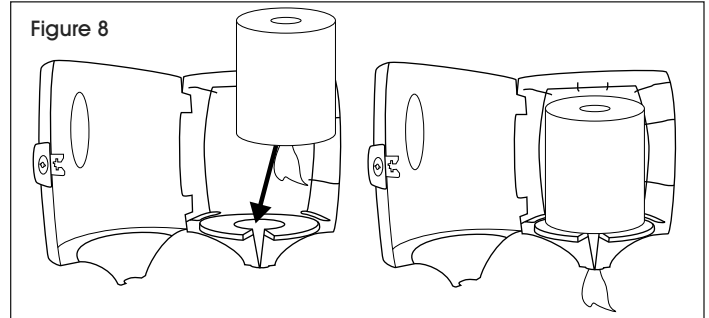

4. Fermez le couvercle et tirez la première lingette pour commencer la distribution.

## CHARGEMENT DES LINGETTES POUR GYMNASSE

 **REMARQUE :** Retournez le distributeur pour que l'ouverture du bas soit orientée vers le haut. (Voir Figure 9)

1. Insérez la clé et tournez-la dans le sens horaire pour ouvrir le couvercle. (Voir Figure 9)

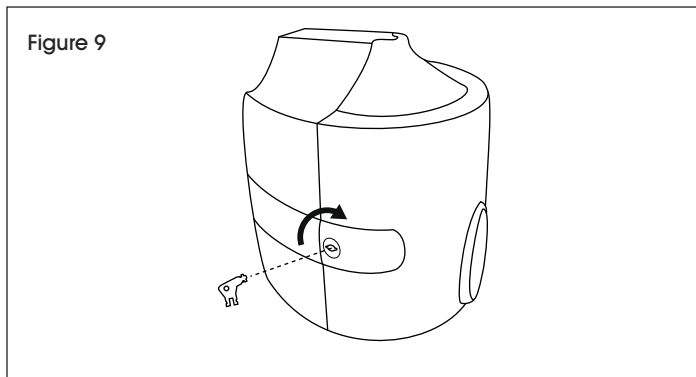

2. Coupez une fente dans la partie supérieure du sac de lingettes humides. Maintenez les lingettes à l'intérieur du sac. (Voir Figure 10)
3. Déposez le sac de lingettes à l'intérieur du distributeur. Faites passer une lingette par l'ouverture pour débiter la distribution. (Voir Figure 10)

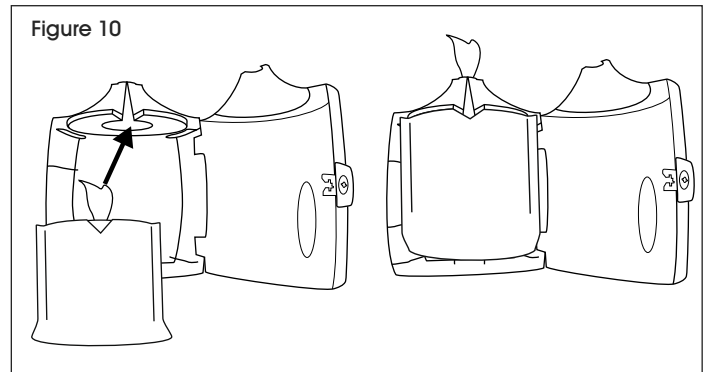

4. Fermez le couvercle.

**ULINE**

1-800-295-5510  
uline.ca