

**ULINE** H-2450  
**GARMENT STORAGE  
 CENTER WITH BASKETS**

1-800-295-5510  
 uline.com



**PARTS**



Connector x 6

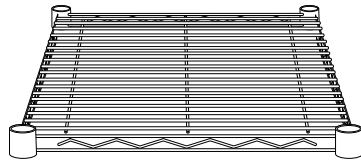

18 x 18" Shelf x 6

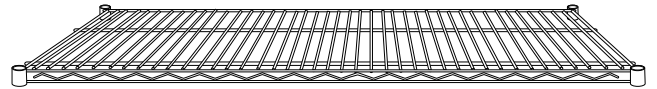

36 x 18" Shelf x 1



Shelf Support (60 Sets)

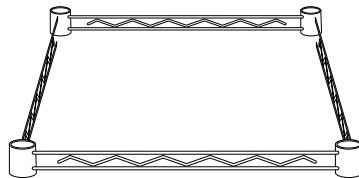

18 x 18" Frame x 2



Garment Rod x 1

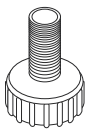

Self-leveler x 8



Basket Support Bar (6 Sets)

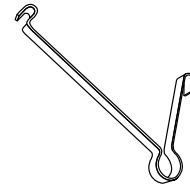

Garment Rod Hanger x 2



Tall Post Top x 6



Tall Post Bottom x 6



Short Post x 2



Pin x 12

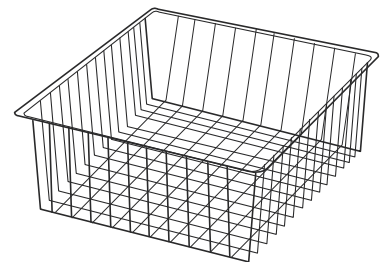

Basket x 6

# ASSEMBLY

## POST ASSEMBLY

1. Connect tall post tops and tall post bottoms to each other by screwing them together. (See Figure 1)

 **NOTE:** Tall post tops have a black plastic cap in the top of the post.

Figure 1



## TO INSTALL SELF-LEVELERS

1. Make sure post is positioned as shown. (See Figure 2)
2. Insert self-leveler into open end of post. Tap on ground to slide self-leveler into post.

Figure 2

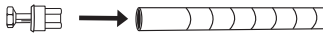

3. Repeat step 2 for all other posts.

## TO INSTALL OPTIONAL CASTERS

1. Make sure post is positioned as shown. (See Figure 3)
2. Engage the wheel brakes to keep casters from rolling during assembly. Use a rubber mallet to tap caster stem into posts. (See Figure 3)

Figure 3

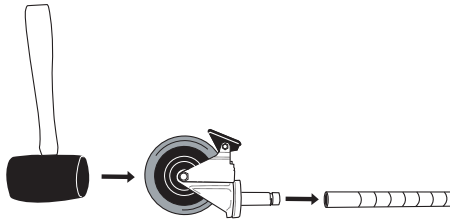

## UNIT ASSEMBLY

1. Snap shelf supports into the very bottom groove of two short and two tall posts. (See Figure 4)
2. Slide posts through underside of square frame until it slides firmly over the supports. (See Figure 5)

Figure 4

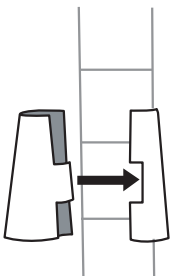
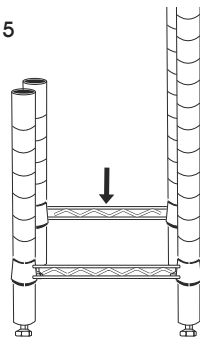
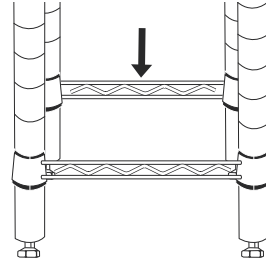

Figure 5



3. Take the other four tall posts, snap shelf supports into the very bottom groove on all four posts. Slide posts through underside of square frame until it slides firmly over the supports. (See Figure 6)

Figure 6



4. Position each of the four posts as shown and snap four sets of shelf supports into the groove directly above the square frames of the inner four posts. (See Figure 7)

Figure 7

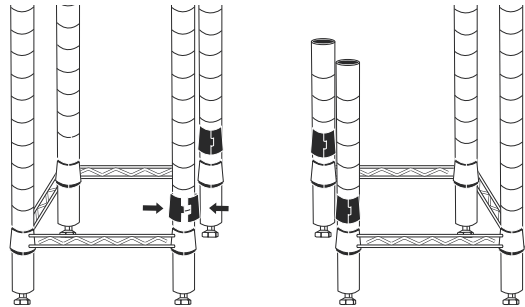

5. Slide a square shelf onto the inner four posts until it slides firmly over the supports. (See Figure 8)

Figure 8

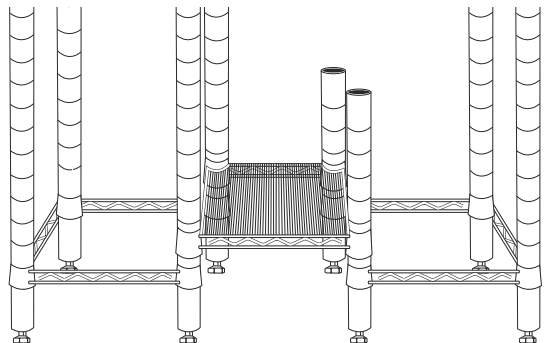

# ASSEMBLY CONTINUED

## UNIT ASSEMBLY CONTINUED

6. Snap four sets of shelf supports onto the outer posts with five grooves visible. And four sets of shelf supports on the inner posts with three grooves visible. (See Figure 9)

Figure 9

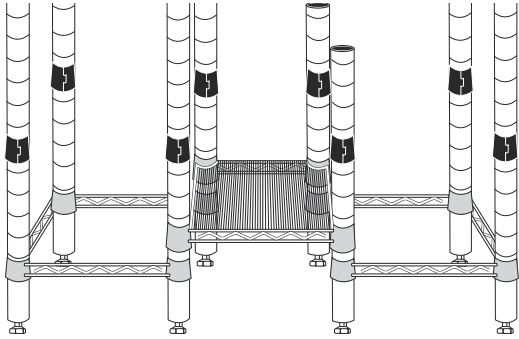

7. Slide four basket support bars onto the posts until bars slide firmly over the supports. (See Figure 10)



**NOTE:** Make sure all the basket support bars have the open end facing the same direction, forward.

Figure 10

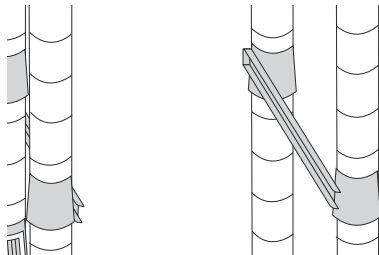

8. Snap eight sets of shelf supports onto the posts with five grooves visible on all eight posts. Slide four basket support bars onto the posts until bars slide firmly over the supports. (See Figure 11)
9. Repeat step 8 one more time. (See Figure 11)

Figure 11

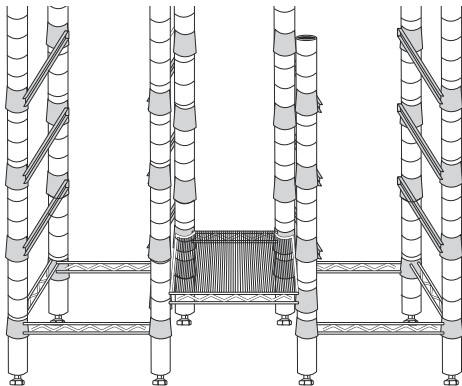

10. Snap eight sets of shelf supports directly above the last set of basket support bars.
11. Slide two square shelves onto the posts until shelves slide firmly over the supports. (See Figure 12)

Figure 12

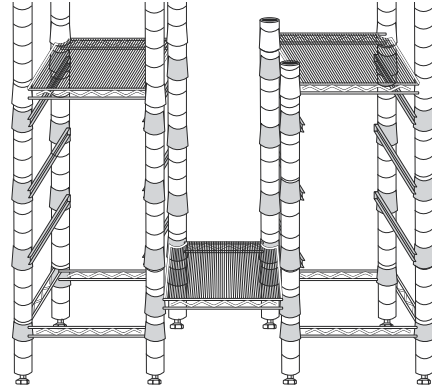

## LEFT SIDE OF THE UNIT

12. Snap four sets of shelf supports onto the left four posts with twelve grooves visible between the lower shelf.
13. Slide a square shelf onto the posts until it slides firmly over the supports. (See Figure 13)
14. Repeat steps 12 and 13 twice. (See Figure 13)

Figure 13

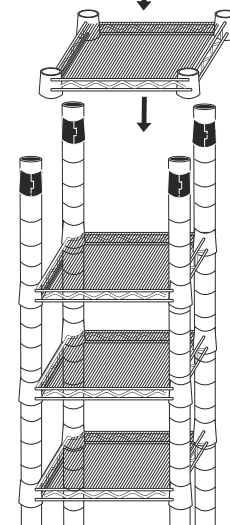

## ASSEMBLY CONTINUED

### RIGHT SIDE OF THE UNIT

15. Snap four sets of shelf supports at the top of the two inner tall posts and two outer posts. (See Figure 14)

16. Slide the rectangular shelf onto the posts until it slides firmly over the supports. (See Figure 14)

Figure 14

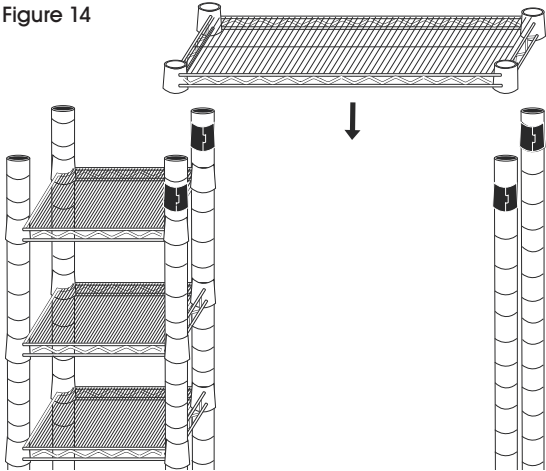

17. Slide garment rod hangers onto garment rod. (See Figure 15)

Figure 15



18. Slide the longer end of garment rod hangers through the shelf wires. (See Figure 16)

Figure 16

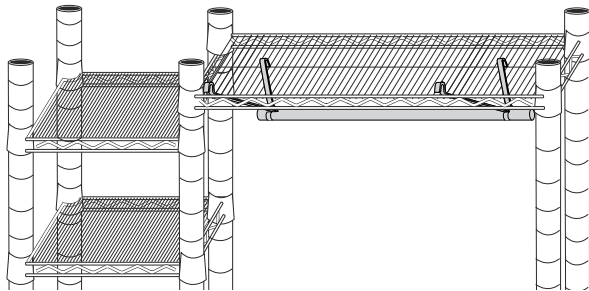

19. Hook the short end of garment rod hangers onto the center wire of the shelf. (See Figure 17)

Figure 17

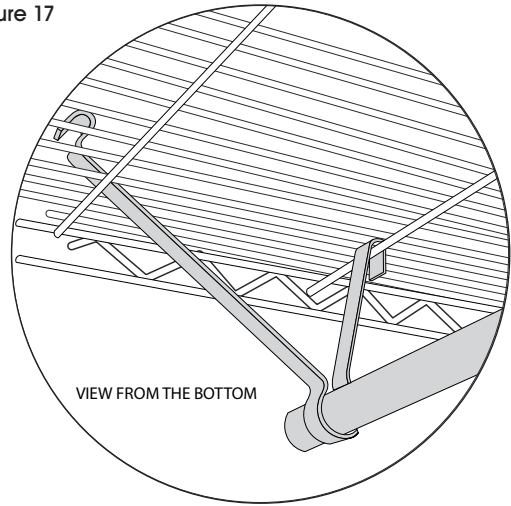

20. Pull garment rod back and down, one side at a time, until long end of garment rod hanger snaps into place.

21. Once unit is assembled, slide the baskets in.

22. Insert pins in the center of the basket support bars.